

C LAB MANUAL

EXERCISE- 1A

AIM : To learn OS Commands, To be Familiar of Editors - vi, Emacs

Operating System : An operating system is a software program that enables the computer hardware to communicate and operate with the computer software. Some examples.

- **Microsoft Windows 7** - PC and IBM compatible operating system. Microsoft Windows is the most common and used operating system.
- **Ubuntu Linux** - A popular variant of Linux used with PC and IBM compatible computers.

OS Commands: Each command of OS can perform a fixed operation.

Syntax: The commands in Linux have the following syntax

\$command options arguments

Basic Commands:

pwd command: 'pwd' command prints the absolute path to current working directory.

```
$ pwd
```

```
/home/raghu
```

cal command: Displays the calendar of the current month.

```
$ cal
```

```
July 2012
```

```
Su Mo Tu We Th Fr Sa
```

```
1 2 3 4 5 6 7
```

```
8 9 10 11 12 13 14
```

```
15 16 17 18 19 20 21
```

```
22 23 24 25 26 27 28
```

```
29 30 31
```

echo command: This command will echo whatever you provide it.

```
$ echo "linoxide.com"
```

```
linoxide.co
```

date command: Displays current time and date.

C LAB MANUAL

\$ date

Fri Jul 6 01:07:09 IS T 2012

tty command: Displays current terminal.

\$ tty

/dev/pts/0

whoami command: This command reveals the user who is currently logged in.

\$ whoami

raghu

Vi editor : vi editor is a visual editor used to create a file (or) to open a file (or) to modify a file.

The command to work with visual editor is

\$ vi filename.c

It can function in different modes.

- Insert mode (I/i or A/a)
- Execute command mode(shift :)
- Escape mode(escape)

Insert mode : In this mode we can enter the data or modify content of a file . By pressing (I/I or A/a) from escape mode we can come to insert mode.

Execute command mode : This is the mode from where we can apply the command mode commands such as : wq → save and quit
: q! → quit without saving

In addition to these commands it can be applied on selected text such as copying, deleting lines etc. From escape mode by pressing Shift + : we can enter into execute command mode.

Escape mode : By default immediately after opening a file through vi editor the file will be in escape mode. We can switch from one mode to another mode.

Emacs editor: emacs is a screen editor. Unlike vi, emacs is not an insertion mode editor, meaning that any character typed in emacs is automatically inserted into the file, **unless** it includes a command prefix.

C LAB MANUAL

Commands in emacs are either control characters (hold down the <Ctrl> key while typing another character) or are prefixed by one of a set of reserved characters: <Esc> or <Ctrl>-X. The <Esc> key can be typed by itself (because it really is a character) and then followed by another character; the <Ctrl> key must be held down while the next character is being typed. The conventions for describing these characters (since it takes too long to type out the whole thing) are ESC means <Esc> and C- means <Ctrl>. One other distinction between emacs and vi is that emacs allows you to edit several files at once. The window for emacs can be divided into several windows, each of which contains a view into a buffer. Each buffer typically corresponds to a different file. Many of the commands listed below are for reading files into new buffers and moving between buffers.

To use emacs on a file, type

\$emacs filename

VIVA-VOCE QUESTIONS:

1. What is vi editor?
2. What are the different modes of vi editor?
3. What is pwd command?
4. What is cal command?
5. What is echo command?

C LAB MANUAL

EXERCISE- 1B

AIM : Basic commands in Linux .

PWD : The pwd command used to know the current working directory. pwd stands for "present working directory" .

Syntax : pwd

ubuntu@ubuntu:~\$ ~/home/Desktop

MAN : This is a command used to get documentation or help on commands or *man* is used for displaying Linux manual pages.

Syntax: \$ man command

example: \$ man mkdir

Displays the manual pages of mkdir .

LS: The ls command can show ('list') the files in your current directory. Used with certain options, you can see sizes of files, when files were made, and permissions of files. Example: "ls ~" will show you the files that are in your home directory.

Syntax:ls

Example : \$ls

Lendi administration hello.c prime.c add.c

CD: The cd command allows us to change directories. When you open a terminal you will be in your home directory. To move around the file system we can use cd.

Syntax : cd directory name

C LAB MANUAL

Example: \$cd lendi

ubuntu@lendi :~\$

CP: The cp command is used to copy files and directories. The copies become independent of the originals (i.e., a subsequent change in one will not affect the other).

Syntax: cp sourcefile destinationfile

Example: cp prime.c primenumber.c

MV: The mv command can move a file to a different location or can rename a file.

Syntax : mv file_name file_name2 (this command renames the file).

example: mv prime.c prime1.c

RM: This command is used to remove or delete a file in your directory.

Syntax: rm filename

example: rm prime.c

MKDIR: The mkdir command is used to create directories.

syntax: mkdir directory name

example: mkdir lendi

RMDIR: The rmdir command used to delete an empty directory.

Syntax: rmdir directory name

example: rmdir lendi

C LAB MANUAL

CAT: cat command displays the content of a file and allows us to create single or multiple files, view contents of file, concatenate files and redirect output into terminal or files.

Syntax: \$ cat filename (displays the content of the file)

Example :\$ cat hello.txt

Hello world !

Appending new data to existing file

syntax: \$ cat newfilename (creates a new file)

example : \$ cat >> hello.txt

Welcome to the c programming lab in lendi engineering college.

\$ cat hello.txt

Hello world !

Welcome to the c programming lab in lendi engineering college.

Ctrl + D or ctrl + Z

VIVA-VOCE QUESTIONS:

1. What is ls command?
2. What is cd command?
3. What is cat command?
4. What is cp command?
5. What is mkdir command?

C LAB MANUAL**EXERCISE 1(C)**

AIM: C Program to Perform Adding, Subtraction, Multiplication and Division of two numbers From Command line.

DESCRIPTION: A c program that uses command line arguments to take parameters to perform addition, Subtraction, Multiplication and Division. As the command line arguments are strings ,here we are using atoi() function which converts string to integer.

Command Line arguments are the arguments that are passed to the program when the program is invoked to for execution. The prototype of main() when it supports command line arguments is as follows:

```
int main(int argc,char *argv[ ])
```

ALGORITHM:

INPUT: 2 Numbers

OUTPUT: Addition, Subtraction, Multiplication and Division of those numbers

STEP-1: Start

STEP-2: a=atoi(argv[1])

STEP-3: b=atoi(argv[2])

STEP-4: Compute sum=a+b

STEP-5: Compute sub=a-b

STEP-6: Compute mul=a*b

STEP-7: Compute div=a/b

STEP-8: Display sum,sub,mul,div

STEP-9: Stop

C LAB MANUAL**SAMPLE OUTPUT:**

\$./a.out 8 4

Sum=12

Sub=4

Mul=32

Div=2

VIVA-VOCE QUESTIONS:

1. What is command line argument?
2. What is the prototype of main() when command line arguments are supported.?
3. Function to convert string to integer?
4. What is the header file of atoi()?
5. Write any C expression to perform any arithmetic operation.

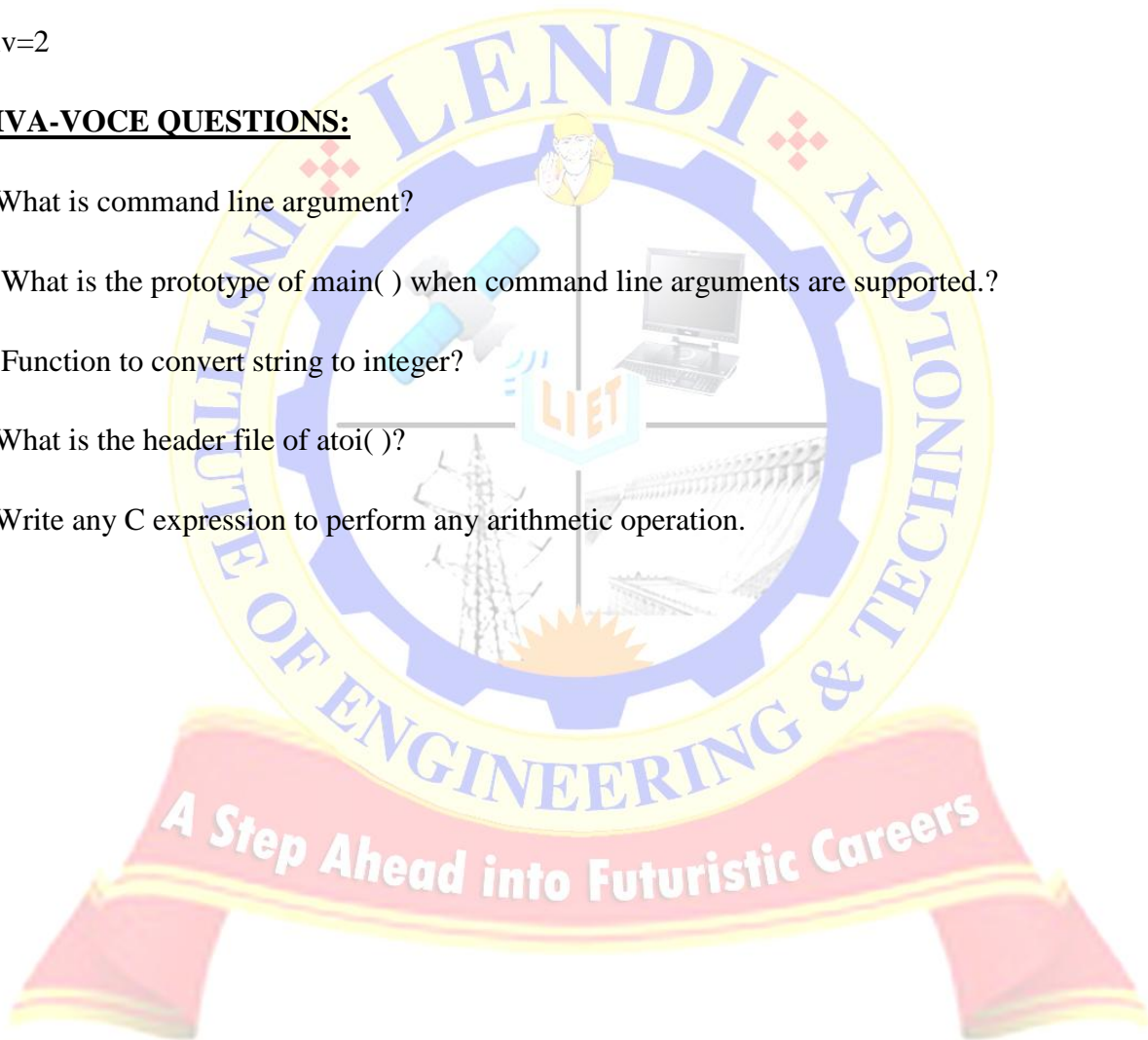

C LAB MANUAL**EXERCISE 2(A)**

AIM: Write a C Program to Simulate 3 Laws at Motion

DESCRIPTION:

Newton's First law An object at rest will remain at rest unless acted on by an unbalanced force. An object in motion continues in motion with the same speed and in the same direction unless acted upon by an unbalanced force. i.e if the force applied on the object is non-zero the object can move in certain direction.

Newton's Second law Acceleration is produced when a force acts on a mass. The greater the mass (of the object being accelerated) the greater the amount of force needed (to accelerate the object).

Force=Mass * Acceleration

Newton's Third law For every action there is an equal and opposite re-action. If force applied is F then its reaction will be -F in the opposite direction.

FIRST LAW**ALGORITHM:**

INPUT: Force(one)

OUTPUT: A Message

STEP-1: Start

STEP-2: Read f

STEP-3: If $f \neq 0$ then display "The object is moving"

Otherwise display "The Object is in the rest"

STEP-4: Stop

C LAB MANUAL**SAMPLE OUTPUT:**

Enter force

3

The object is moving

SECOND LAW**ALGORITHM:**

INPUT: 2 Numbers(m,a)

OUTPUT: Force(one)

STEP-1: Start

STEP-2: Read m,a

STEP-3: Compute $f=m*a$

STEP-4: Display f

STEP-5: Stop

SAMPLE OUTPUT:

Enter mass and acceleration

3 4

Force = 12

THIRD LAW**ALGORITHM:**

INPUT: One(Force)

OUTPUT: One (Force)

C LAB MANUAL

STEP-1: Start

STEP-2:Read f

STEP-3: Compute $f=-f$

STEP-4: Display f

STEP-5:Stop

SAMPLE OUTPUT:

Enter force

3

F=-3

VIVA-VOCE QUESTIONS:

1. What is the associativity of assignment operator?
2. Write syntax of conditional statement?
3. What is the result of any relational expression?
4. How $f=m*a$ can be evaluated?
5. What is the meaning of unary mainus?

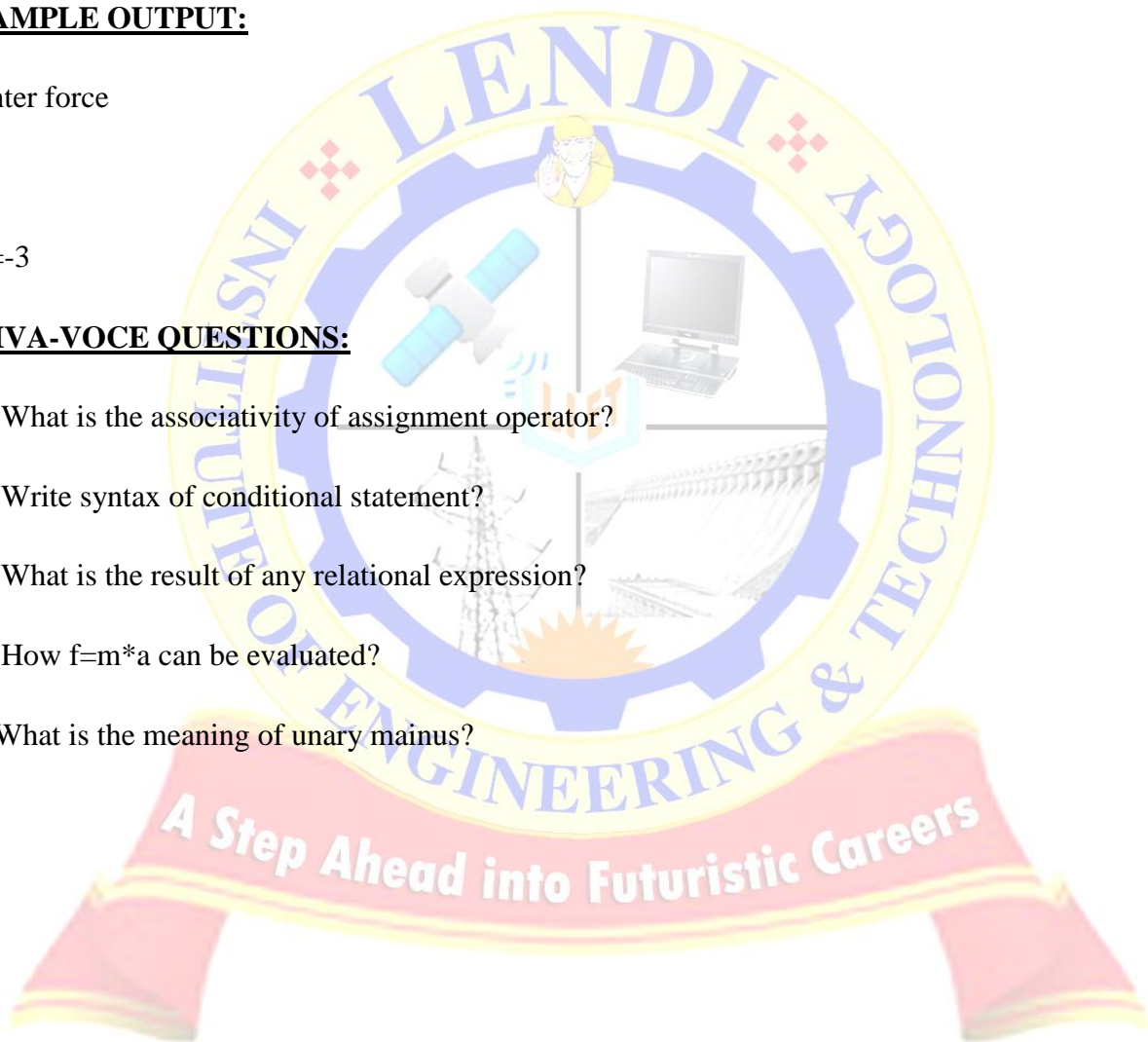

C LAB MANUAL**EXERCISE 2(B)**

AIM: Write a C Program to convert Celsius to Fahrenheit and vice versa

DESCRIPTION: Temperature in Centigrade or Fahrenheit is taken and converted in to other form using following formula.

TEMPERATURE CONVERSION TABLE

From	To	Formula
Fahrenheit (F)	Celsius (C or °)	$(F - 32) * 5/9$
Celsius (C or °)	Fahrenheit (F)	$(C * 9/5) + 32$

FAHRENHEIT TO CELSIUS CONVERSION**ALGORITHM:**

INPUT: Fahrenheit (one)

OUTPUT: Celsius (one)

STEP-1: Start

STEP-2: Read f

STEP-3: Compute $c=(f-32)*5/9$

STEP-4: Display c

STEP-5: Stop

SAMPLE OUTPUT:

Enter temperature in Fahrenheit : 40

Temperature in Celsius=4.4

CELSIUS TO FAHRENHEIT CONVERSION

C LAB MANUAL**ALGORITHM:**

INPUT: Celsius (one)

OUTPUT: Fahrenheit (one)

STEP-1: Start

STEP-2: Read c

STEP-3: Compute $f=9*c/5+32$

STEP-4: Display f

STEP-5: Stop

SAMPLE OUTPUT:

Enter temperature in Celsius: 4.4

Temperature in Fahrenheit: 40

VIVA-VOCE QUESTIONS:

1. How an expression can be executed?
2. Explain how the expression $f=9*c/5+32$ is evaluated?
3. What is the priority of * (multiplication) operator?
4. What is the priority of / (Division) operator?
5. When an expression consisting of operators with same priority how they can be evaluated.

C LAB MANUAL**EXERCISE 3(A)**

AIM: Write a C Program to Find Whether the Given Year is a Leap Year or not.

DESCRIPTION: Divide the year with 4 if resultant remainder is zero then the year is leap year otherwise it is a non-leap year. We can use if –else or conditional statement to write the program.

ALGORITHM:

INPUT: One Number

OUTPUT: A message

STEP-1: Start

STEP-2: Read a

STEP-3: If $a \% 4 \neq 0$ then display “It is a leap year”

Otherwise “it is not a leap year”

STEP-4: Stop

SAMPLE OUTPUT:

➤ Enter year: 2000

This is a leap year

➤ Enter year: 2001

This is not leap year

VIVA-VOCE QUESTIONS:

1. Which operator can't be used on float data?
2. What do you mean by decision making statement?
3. Write syntax for if-statement
4. What are the restrictions on % operator?
5. What is multi-way decision making statement?

C LAB MANUAL**EXERCISE 3(B)**

AIM: Write a C Program to Add Digits & Multiplication of digits of a number

DESCRIPTION: From the given number extract the digits then add them and multiply them. We can extract a digit using % operator. Here while loop is preferable because this is the case of event control loop.

ALGORITHM:

INPUT: A number

OUTPUT: Sum and multiplication of digits number

STEP 1: Start

STEP 2: Read n

STEP 3: Initialize temp=n; sum=0,mul=1

STEP 4: If temp>0 then go to STEP-5

Otherwise goto STEP-6

STEP 5: Compute dig<- temp%10

Compute sum<-sum+dig

Compute mul<- mul* dig

Compute temp<-temp/1 and go to STEP-4

Step 6: Display sum,mul

Step 7: Stop

C LAB MANUAL**SAMPLE OUTPUT:**

Enter your number: 123

Sum of digits: 6

Multiplication of digits: 6

VIVA-VOCE QUESTIONS:

1. What is loop?
2. What are different types of loop?
3. What is entry control loop?
4. Write syntax of while-loop.
5. What is event control loop?

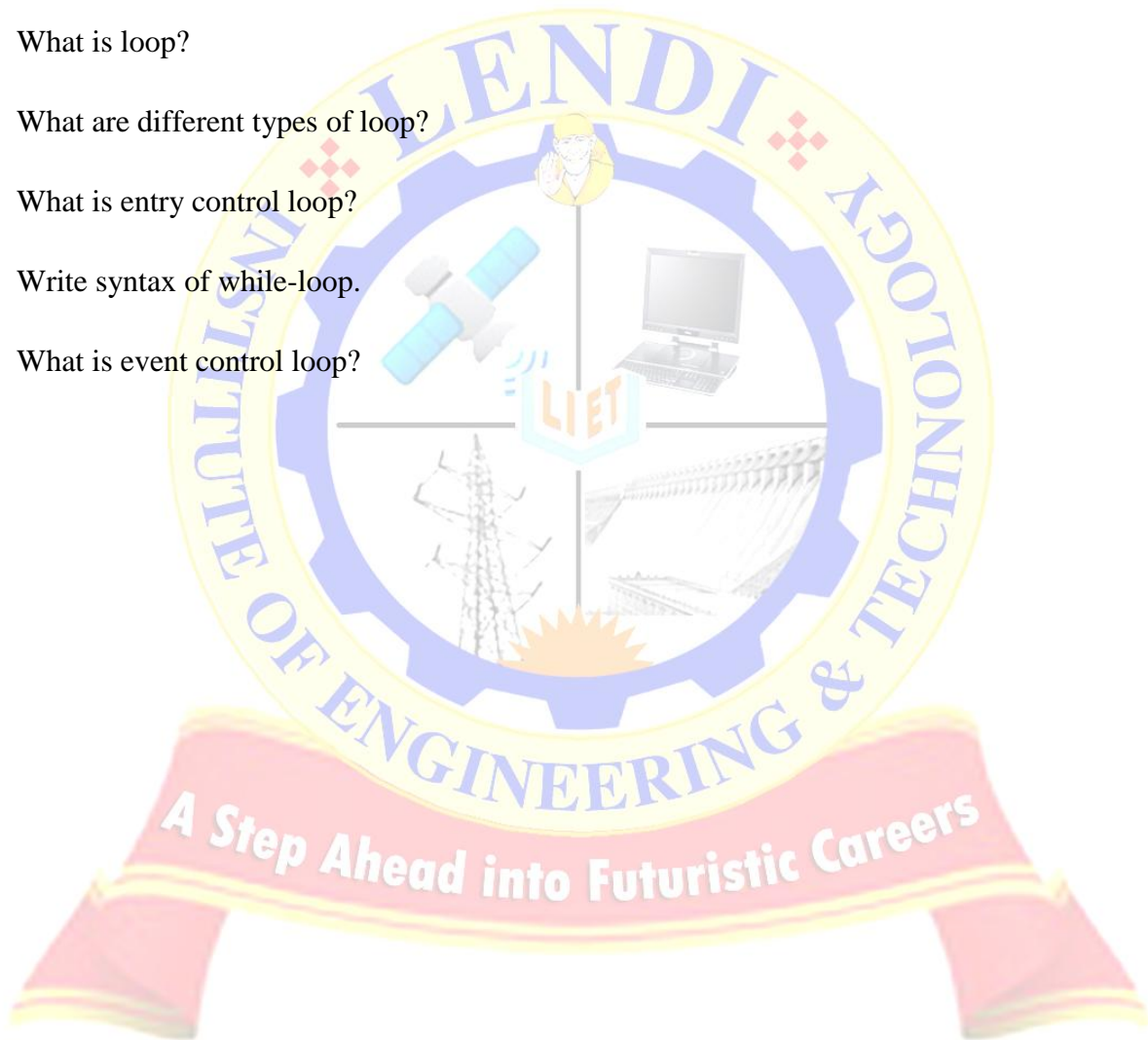

C LAB MANUAL**EXERCISE 4(A.I)**

AIM: Write a C Program to Find Whether the Given Number is Prime Number.

DESCRIPTION: The number which is not having any factor from 2 to $n/2$ is called a prime number. Computing the factors from 2 to $n/2$ and if there is no factor the number is prime otherwise the number non-prime. Here for loop is preferred because it is the case of counter control loop.

ALGORITHM:

INPUT: One Number

OUTPUT: A message

STEP-1:Start

STEP-2:Read n

STEP-3: Initialize $i=2, \text{flag}=1$

STEP-4: If $i \leq n/2$ then go to STEP-5

Otherwise go to STEP-7

STEP-5: If $n \% i = 0$ then $\text{flag}=0$ and go to STEP-7

STEP-6: Compute $i=i+1$ and go to STEP-4

STEP-7: If $\text{flag}=1$ then display "Prime Number"

Otherwise display "Not a Prime Number"

STEP-8: Stop

C LAB MANUAL**SAMPLE OUTPUT:**

➤ Enter a number:7

This is a prime number

➤ Enter a number:9

This is not a prime number



C LAB MANUAL**EXERCISE 4 (A.II)**

AIM: Write a C Program to Find Whether the Given Number is Armstrong Number.

DESCRIPTION: The number for which the sum of the n^{th} powers of digits of given number is equal to the number itself then it an Armstrong number .Where n is the number of digits of the given number. Example : 153.

ALGORITHM:

INPUT: One Number

OUTPUT: A message

STEP-1:Start

STEP-2:Read n

STEP-3:Initialize temp=n,sum=0

STEP-4: If temp>0 then go to STEP-5

Otherwise go to STEP-7

STEP 5:Compute nd=nd+1

STEP-6: Compute temp=temp/1 and go to STEP-4

STEP-7:Compute temp=n

STEP-8: If temp>0 then go to STEP-9

Otherwise go to STEP-10

STEP 9:Compute dig=temp%10

Compute sum=sum+pow(dig,nd)

Compute temp=temp/1 and go to STEP-8

C LAB MANUAL

STEP-10: If $n = \text{sum}$ then display this an armstrong number

Otherwise display this is not an armstrong number

STEP-7: Stop

SAMPLE OUTPUT:

➤ Enter a number: 153

This an Armstrong number

➤ Enter a number: 154

This not an Armstrong number

VIVA-VOCE QUESTIONS:

1. Write syntax of for loop?
2. What is prime number?
3. What is Armstrong number?
4. What is the prototype of `pow()` ?
5. What is pre-increment operator?

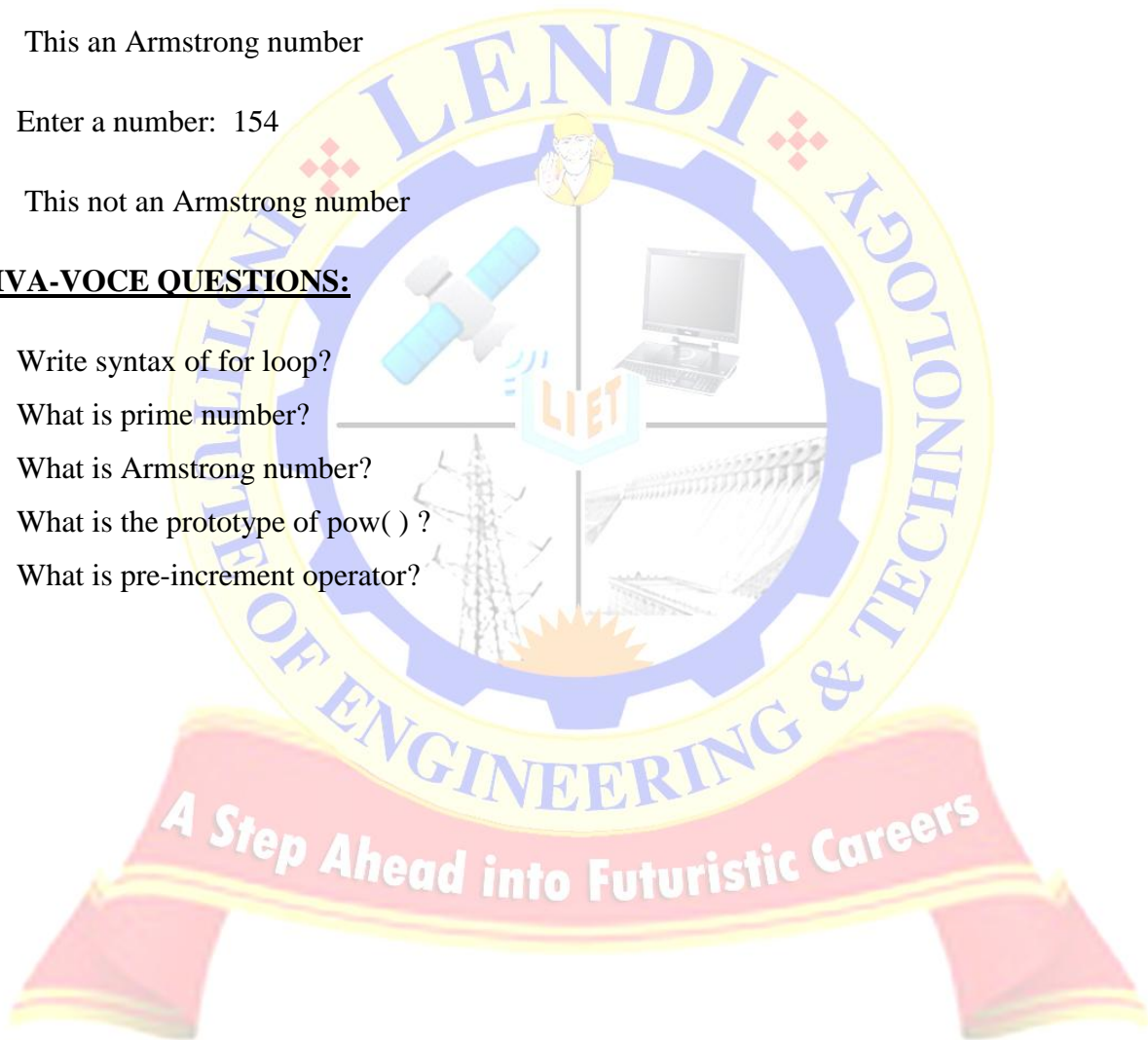

C LAB MANUAL**EXERCISE 4(B)**

AIM: Write a C program to print Floyd Triangle

DESCRIPTION: Display the numbers in the following format is the Floyd Triangle. Where user can enter number of rows.

```

1
2   3
4   5   6
7   8   9   10

```

This can be implemented using nested looping.

ALGORITHM:

INPUT: One number

OUTPUT: Floyd Triangle

STEP-1: Start

STEP-2: Read n

STEP-3: Initialize a=1,i=1,j=1

STEP-4: If $i \leq n$ then go to STEP-5

Otherwise go to STEP-9

STEP-5: If $j \leq i$ then go to STEP-6

Otherwise go to STEP-8

STEP-6: Display a

C LAB MANUAL

STEP-7: Compute $a=a+1, j=j+1$ and go to STEP-6

STEP-8: Display "\n", compute $i=i+1$ and go to STEP-4

STEP-9: Stop

SAMPLE OUTPUT:

Enter your number : 4

The Floyd Triangle

```
1
2  3
4  5  6
7  8  9 10
```



C LAB MANUAL**EXERCISE 4(C)**

AIM: Write a C Program to print Pascal Triangle

DESCRIPTION: A Pascal triangle represents the binomial coefficients of the binomials. Example Pascal triangle is as follows.

```

1
1 1
1 2 1
1 3 3 1

```

Here user can take the number of rows. Here also we can use nest loops.

ALGORITHM:

INPUT: One number

OUTPUT: Pascal Triangle

STEP-1: Start

STEP-2: Read n

STEP-3: Initialize $i=0, j=0$

STEP-4: If $i \leq n$ then go to STEP-5

Otherwise go to STEP-11

STEP-5: If $j \leq (n-i-2)$ then display “\t” and go to STEP-6

Otherwise go to STEP-7

STEP-6: Compute $j=j+1$ and go to STEP-5

STEP-7: If $j \leq I$ then go to STEP-8

C LAB MANUAL

Otherwise go to STEP-4

STEP-8: Compute $n = \text{fact}(i) / \text{fact}(j) * \text{fact}(i-j)$

STEP-9: Compute $j = j + 1$

STEP-10: Display “\n” and go to STEP-7

STEP-11: Stop

SAMPLE OUTPUT:

Enter your number : 4

The Pascal Triangle

```
1
1 1
1 2 1
1 3 3 1
```

VIVA-VOCE QUESTIONS:

1. What is Floyd Triangle?
2. What is Pascal Triangle?
3. What is nested-loop?
4. What happens if the condition is omitted in the for-loop?
5. What is ‘\t’?

C LAB MANUAL**EXERCISE 5 (A)**

AIM: Write a C Program demonstrating of parameter passing in Functions and returning values.

DESCRIPTION: There are categories of functions depends on return value and parameters.

They are

1. Function with parameters and return value.
2. Function without parameters and with return value.
3. Function with parameters and without return value.
4. Function without parameters and without return value.
5. Function returns multiple values.

Example prototypes are: 1. `int sum(int a,int b);`

2. `int sum();`

3. `void sum(int a,int b);`

4. `void sum(void);`

ALGORITHM:

A sample algorithm for `int sum(int a,int b);`

INPUT: 2 Numbers as arguments

OUTPUT: Sum of them

STEP-1:Start

STEP-2:Compute `res= a+b`

STEP-3:Return `res`

C LAB MANUAL

A sample algorithm for main()

STEP-1:Start

STEP-2: Read a,b

STEP-3:c=sum(a,b)

STEP-4: Display c

STEP-5: Stop

SAMPLE OUTPUT:

Enter two numbers: 4 5

Sum=9

VIVA-VOCE QUESTIONS:

1. What is function?
2. What are the types of functions based on parameters and return values?
3. How the execution of program will be when there is a function call?
4. What is return keyword?
5. What is user defined function?

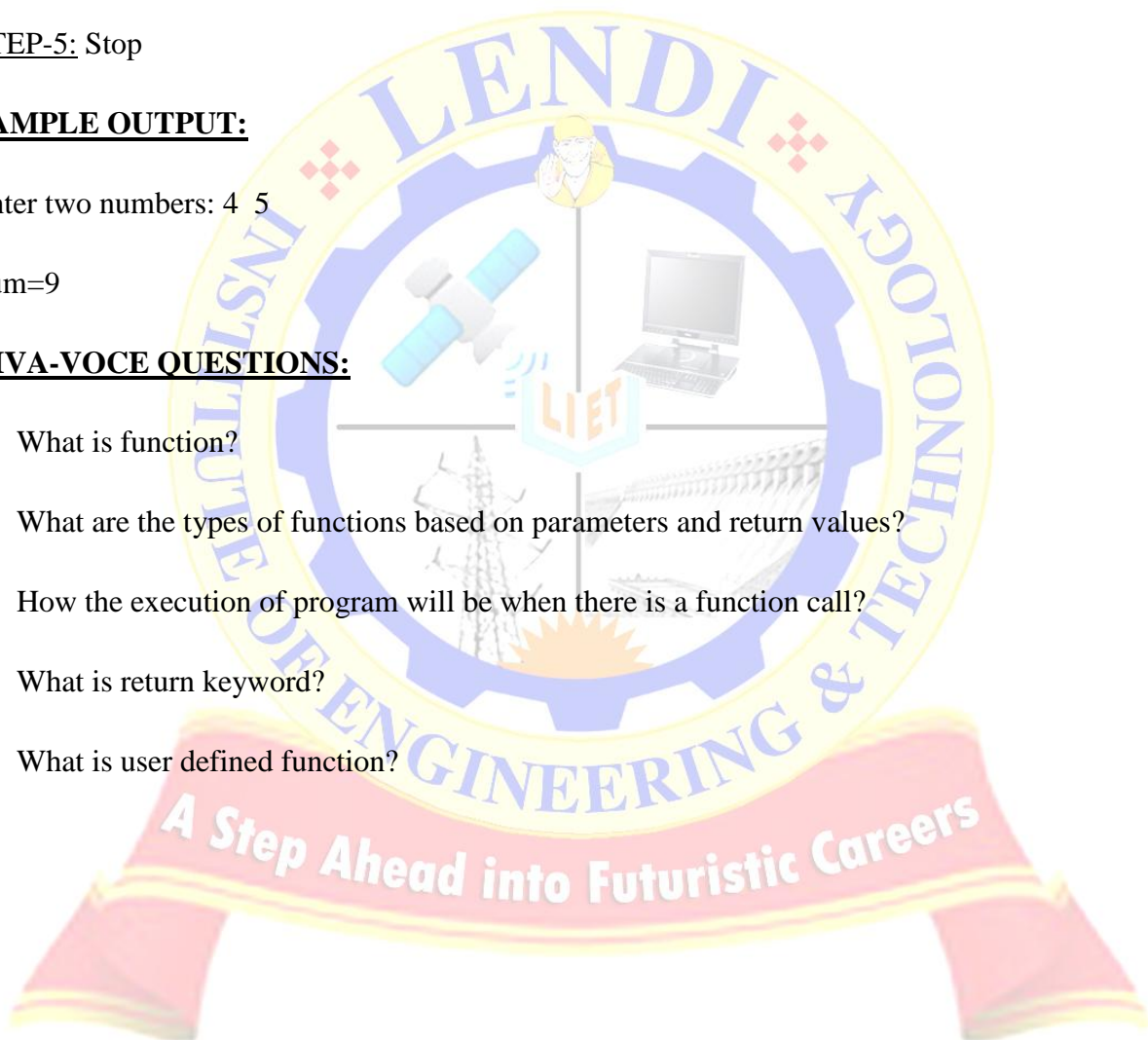

C LAB MANUAL**EXERCISE 5(B)**

AIM: Write a C Program illustrating Fibonacci, Factorial with Recursion without Recursion

DESCRIPTION:

1. Fibonacci series is defined as $f_n = f_{(n-1)} + f_{(n-2)}$ where $n > 2$ and $f_0 = 0$ and $f_1 = 1$. The example series is 0,1,1,2,3,5,8.....etc.

2. Defining a function in terms of itself is called recursive function.

3. Recursive definition of factorial: $n! = n * (n-1)!$

Factorial using recursion**ALGORITHM:**

INPUT: One Number

OUTPUT: Factorial of the number

A sample algorithm for `main()`

STEP-1: Start

STEP-2: Read n

STEP-3: result = fact(n)

STEP-4: Display result

STEP-5: Stop

int fact (int n) :

STEP-1: Start

STEP-2: if (n = 1) then return 1

else return n*fact(n-1)

C LAB MANUAL**SAMPLE OUTPUT:**

Enter your number: 5

Factorial of 5 is: 120

Factorial using non-recursion**ALGORITHM:**

INPUT: One Number

OUTPUT: Factorial of the number

A sample algorithm for main()

STEP-1:Start

STEP-2:Read n

STEP-3:result= fact(n)

STEP-4: Display result

STEP-5:Stop

int fact (int n) :

STEP-1: Start

STEP-2 initialize res=1,i=2

STEP-3:loop(i<=n)

res=res*i

i++

repeat loop

STEP-4: Return res

C LAB MANUAL**SAMPLE OUTPUT:**

Enter your number: 5

Factorial of 5 is: 120

Fibonacci series using recursion**ALGORITHM:**

A sample algorithm for main()

INPUT: A Number

OUTPUT: Fibonacci series up to n terms

STEP-1:Start

STEP-2:Read n

STEP-3:initialize i=0

STEP-4: loop(i<=n)

res= fib(i)

display res

i++

repeat loop

STEP-4: Stop

fib(int n):

STEP-1:Start

STEP-2: if(n= =0)

return 0

else if(n= =1)

return 1

else return fib(n-1)+fib(n-2)

C LAB MANUAL**SAMPLE OUTPUT:**

Enter the a number : 5

The Fibonacci series is: 0 1 2 3 5 8

Fibonacci series using non -recursive**ALGORITHM:**

A sample algorithm for main()

INPUT: A Number

OUTPUT: Fibonacci series up to n terms

STEP-1:Start

STEP-2:Read n

STEP-3:call fibseries(n)

STEP-4:Stop

fibseries(int n):

STEP-1:Start

STEP-2: Initialize f0=0,f1=1,term,i=2

STEP-3:Display f0,f1

STEP-4: loop(i>=n)

term=f0+f1

display term

f0=f1

f1=term

i++

repeat loop

STEP-5:Stop

C LAB MANUAL**SAMPLE OUTPUT:**

Enter the a number : 5

The Fibonacci series is: 0 1 2 3 5 8

VIVA-VOCE QUESTIONS:

1. What is iterative function?
2. What is recursive function?
3. What is the difference between iterative function and recursive function?
4. What is Fibonacci – series?
5. How recursive function can be executed?

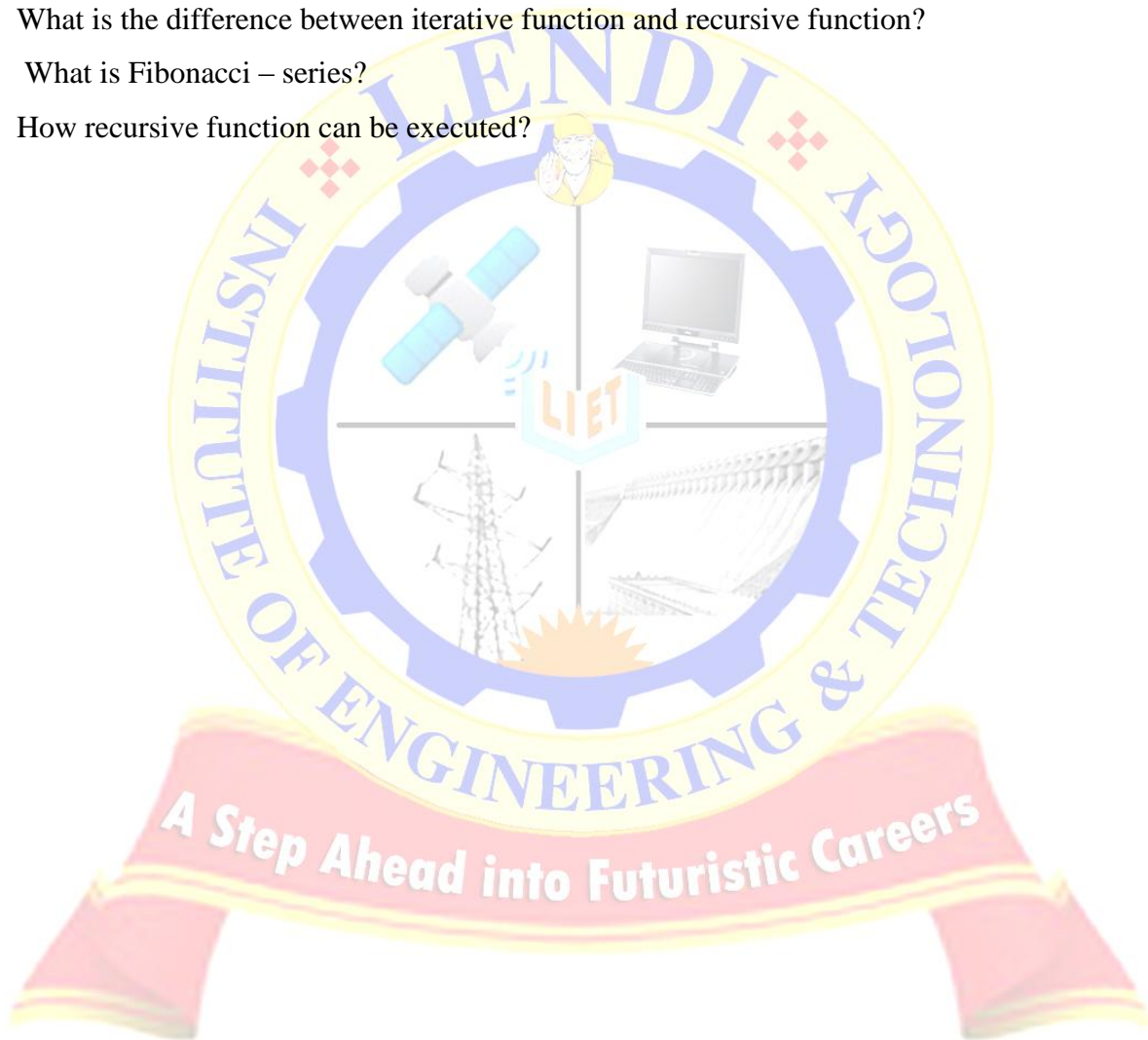

C LAB MANUAL**EXERCISE -6A**

AIM: Write a C Program to make a simple Calculator to Add, Subtract, Multiply or Divide Using switch...case

DESCRIPTION: switch case is multi way decision making statement.

Syntax:

switch (control variable)

```
{
  case constant-1:
    statement(s);
    break;
  case constant-2:
    statement(s);
    break;
  ...
  case constant-N
    statement(s);
    break;
  default:
    statement(s);
}
```

Here for the problem we can take operator and operands from the user and based on the operator the operation can be done. This was asked to do using switch-case

ALGORITHM:

STEP-1. Start

STEP-2: Initialize i=0

C LAB MANUAL

STEP-3: read n

STEP-4: loop (n!=0)

r=n%2

a[i]=r

i++

n=n/2

Repeat loop

STEP-5: Display array a

STEP-6: stop

SAMPLE OUTPUT:

enter a,b values2 3

1.add

2.sub

3.mul

4.div

enter your choice1

2+3=5

enter a,b values2 3

1.add

2.sub

3.mul

4.div

enter your choice2

2-3=-1

enter a,b values2 3

C LAB MANUAL

1.add

2.sub

3.mul

4.div

enter your choice3

2*3=6

enter a,b values2 3

1.add

2.sub

3.mul

4.div

enter your choice4

2/3=0.666667

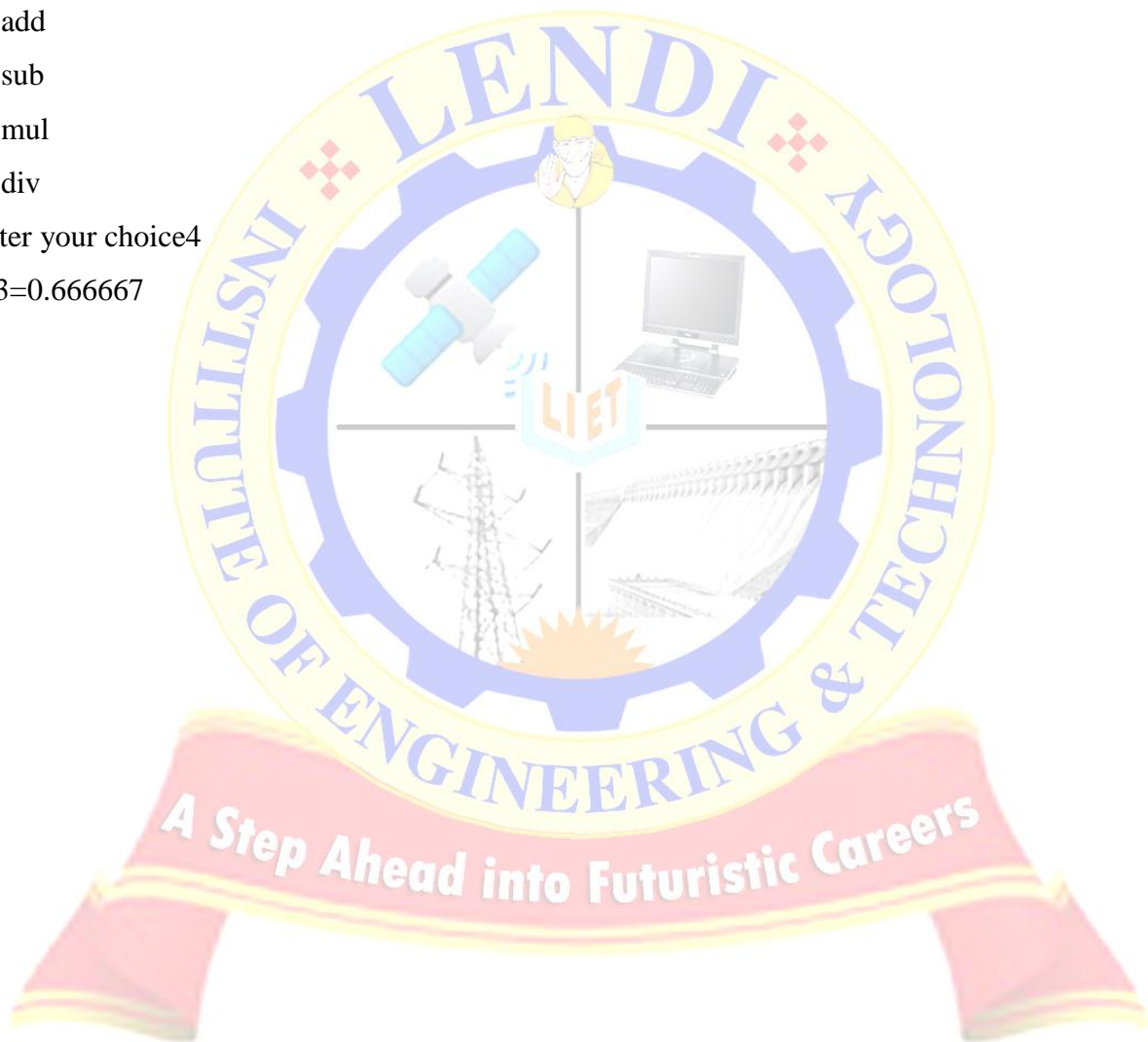

C LAB MANUAL**EXERCISE -6B**

AIM: Write a C Program to convert decimal to binary and hex (using switch call function the function)

DESCRIPTION: Base of binary number is 2 and digits are 0 and 1. Base of hexa decimal number is 16 and digits are 0-9 and 'A'-'F'. Here we can use function to do conversion from decimal to binary and hexadecimal using conversion techniques.

ALGORITHM: DTOH () FUNCTION:

STEP-1. Start

STEP-2. Declare i=1, j, dec,rem, hexa[100],temp;

STEP-3. Read decimal number

STEP-4.while(dec!=0) do

- 4.1 rem=dec%16;
- 4.2 if(rem>9)
 - 4.2.1 temp=rem+55;
- 4.3 else
 - 4.3.1 temp=rem+48;
- 4.4 hexa[i++]=temp;
- 4.5 dec=dec/16;

STEP-5. print decimal to hexa is

STEP-6. for (j=i;j>0;j--) then

- 6.1 print hexa[j]

ALGORITHM: DTOB () FUNCTION:

STEP-1. Start

STEP-2. Declare i=1,j,dec,rem, bin[100];

STEP-3. Read Decimal numbe

C LAB MANUAL

STEP-4. while (dec!=0) do

```

4.1   rem=dec%2;
      4.2   bin[i++]=rem;
      4.5   dec=dec/2;

```

STEP-5. printf("\nDecimal; to binary");

STEP-6. for(j=i;j>0;j--) then

STEP-7. print bin[j]

SAMPLE OUTPUT:

1.Decimal to Hexa

2.Decimal to Binary

Enter your choice1

Enter the decimal number42

Decimal to Hexa is:2A

1.Decimal to Hexa

2.Decimal to Binary

Enter your choice2

Enter the Decimal number42

Decimal to binary0101010

VIVA-VOCE QUESTIONS:

1. What is Armstrong number?
2. How convert decimal number in to binary?
3. The operator to get remainder in division process?
4. What is array?
5. What is the functionality of power()?

C LAB MANUAL**EXERCISE -7**

AIM: Write a C Program to compute the values of sin x and cos x and ex values using Series expansion. (Use factorial function)

DESCRIPTION:

The expansions of the series

1. $\sin(x): x - (1/3!)x^3 + (1/5!)x^5 - (1/7!)x^7 + \dots$
2. $\cos(x): 1 - (1/2!)x^2 + (1/4!)x^4 - (1/6!)x^6 + \dots$
3. $e^x = 1 + x + x^2/2! + x^3/3! + x^4/4! + \dots$

Here we can use factorial function and for loop to compute the series.

ALGORITHM: FACTORIAL (INT)

STEP-1. Start

STEP-2. Declare I,fact=1;

STEP-3. if(n==0)

3.1 return 1;

STEP-4 else

4.1 for (i=1;i<=n;i++) then

4.1.1 fact*=i;

STEP-5. return fact;

STEP-6. Stop

ALGORITHM: SIN(X)

STEP-1. Declare x,sum=0,fraction=0,n,i,j; /*the declarations*/

STEP-2. Declare factorial(int);

STEP-3. Read degree to calculate

STEP-4. Read number of terms

STEP-5. for(i=1,j=0;i<=n,j<n;i=i+2,j++) then

5.1 fraction=pow(-1,j)*(float)(pow(x,i)/factorial(i));/*each term*/

C LAB MANUAL

5.2 sum+=fraction; /* summing up*/

STEP-6. Print sum;

STEP-7. Stop

ALGORITHM: COS(X)

STEP-1. Declare int n,x1,i,j,x,sign,cosx

STEP-2. Declare factorial(int);

STEP-3. Read degree to calculate

STEP-4. Read number of terms

STEP-5. x1=x;

STEP-6. x=x*(3.142/180.0); /* Degrees to radians*/

STEP-7. cosx=1;

STEP-8. sign=-1;

STEP- 9. for(i=2;i<=n;i=i+2) then

9.1 cosx=cosx+(pow(x,i)/fact(i))*sign;

9.2 sign=sign*(-1);

STEP-10. Print cosx

STEP-11. Stop

ALGORITHM: EXP(X)

STEP-1,Start

STEP-2. Declare x, n, fact(int), i, j,float sum=1;

STEP-3. Read x,n

STEP-4. for(i=1; i<=n ; i++)

4.1 sum=sum+(pow(x,i) / fact(i));

STEP-6. print sum

STEP- 7. Stop

SAMPLEOUTPUT:

Enter the number of the terms in series

5

Enter the value of x(in degrees)

C LAB MANUAL

60

Sum of the cosine series = 0.50

The value of $\cos(60)$ using library function = 0.499882**SAMPLE OUTPUT:**

enter the x value 4

enter the no of terms 6

the exp(4) value is : 48.555553

the actual exp(4) value is : 54.598150

VIVA-VOCE QUESTIONS:

1. What is the function?
2. What are the different types of functions?
3. What is the return statement?
4. Classification of functions

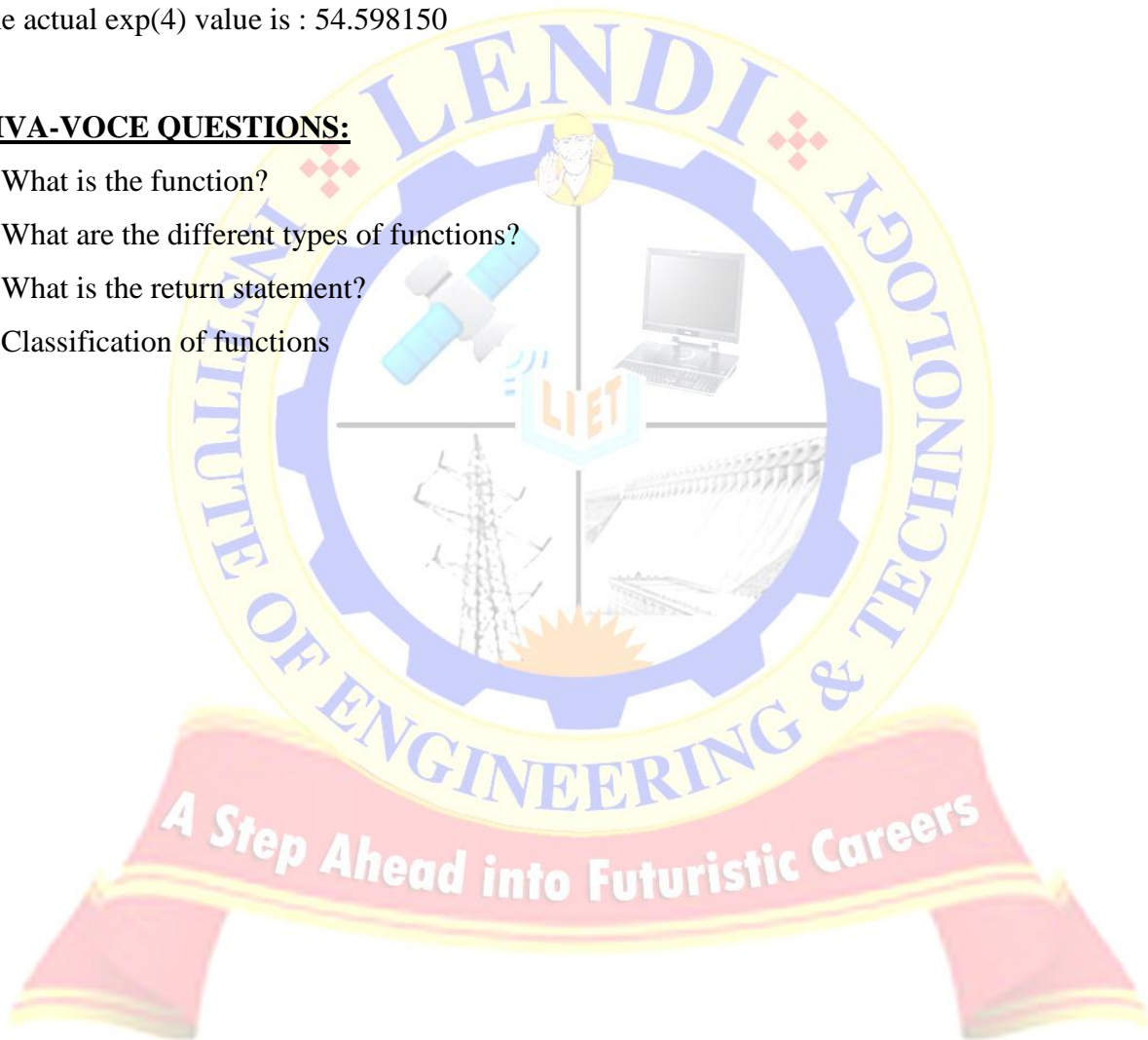

C LAB MANUAL**EXERCISE- 8A**

AIM: Write a c program to implement linear search.

DESCRIPTION: linear search (Searching algorithm) which is used to find whether a given number is present in an array and if it is present then at what location it occurs. It is also known as sequential search. It is very simple and works as follows: We keep on comparing each element with the element to search until the desired element is found or list ends. Linear search in c language for multiple occurrences and using function

ALGORITHM:

STEP-1. Start

STEP-2. Declare n,i,a[10],key

STEP-3. Read n

STEP-4. for (i=0;i<n;i++) then

4.1 Read a[i]

STEP-5. Read key

STEP-6. for(i=0;i<n;i++)

6.1 if(a[i]==key)

6.1.1 print element found at position

6.1.2 exit(0);

6.2 end if

STEP-7. end for

STEP-8. print key not found

SAMPLE OUTPUT:

1) enter the no of elements4
 enter the elements1 2 3 4
 enter the key to search3
 the key element 3 found at 3 position

2) enter the no of elements4

C LAB MANUAL

enter the elements2

4

5

3

enter the key to search7

key 7 not found

VIVA-VOCE QUESTIONS:

1. What is searching?
2. What is the difference between linear search and binary search?
3. What are the boundaries of an array index?
4. What can be the data type of an array index?
5. What is one dimensional array?

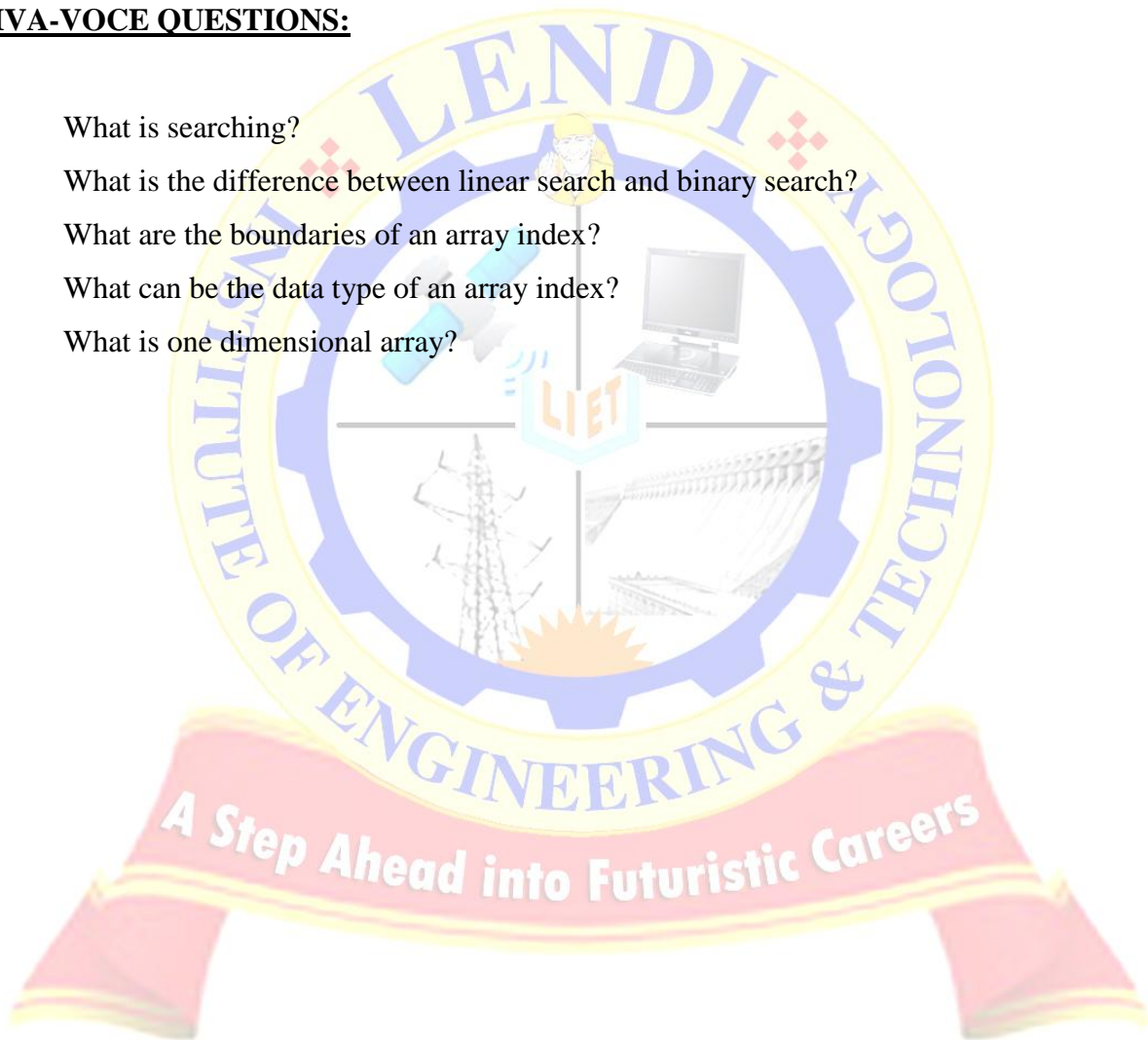

C LAB MANUAL**EXERCISE -8B**

AIM: Write a c program to sort array of elements using bubble sort and selection sort.

DESCRIPTION: The process of arranging the elements either in ascending order or descending order is called sorting.

Bubble sort: In this process in each iteration the greatest or least element can get its position

Selection sort: In this process in each iteration the position of the element is fixed

ALGORITHM: BUBBLE SORT

STEP-1. Start

STEP-2. Declare n,i,a[10],j,t;

STEP-3. Read n

STEP-4. Print enter the elements

STEP-5. for(i=0;i<n;i++) then

STEP-6. Read a[i]

STEP-7. End for

STEP-8. for(i=0;i<n;i++) then
8.1 for(j=i+1;j<n;j++) then

8.1.1 if(a[i]>a[j])

8.1.1.1 t=a[i];

8.1.1.2 a[i]=a[j];

8.1.1.2 a[j]=t;

End if

STEP-9. End for

STEP-10. End for

STEP-11. Print the sorted list is

STEP-12. for(i=0;i<n;i++) then

STEP-13. Print a[i]

STEP-14. End for

STEP-15. Stop

C LAB MANUAL**ALGORITHM: SELECTION SORT**

1. Start
2. Declare n,i,a[10],j,pos,t
3. Read n
4. Print enter the elements
5. for(i=0;i<n;i++) then
6. Read a[i]
7. End for
8. for(i=0;i<n;i++)
 - 8.1 pos=i;
 - 8.2 for(j=i+1;j<n;j++)
 - 8.2.1 if(a[pos]>a[j])
 - 8.2.1.1 pos=j;
 - 8.2.2 end if
 - 8.3 end for
 - 8.4 if(pos!=i)
 - 8.4.1 t=a[i];
 - 8.4.2 a[i]=a[pos];
 - 8.4.3 a[pos]=t;
9. End for
10. Print the sorted list is
11. for(i=0;i<n;i++) then
12. Print a[i]
13. End for
14. Stop

C LAB MANUAL**SELECTION SORT SAMPLE OUTPUT:**

Enter the no of elements4

Enter the elements

10

3

78

9

the sorted list is :

3

9

10

78

BUBBLE SORT SAMPLE OUTPUT:

Enter the no. of elements5

Enter the elements0

4

5

1

2

The sorted list is:

0

1

2

4

5

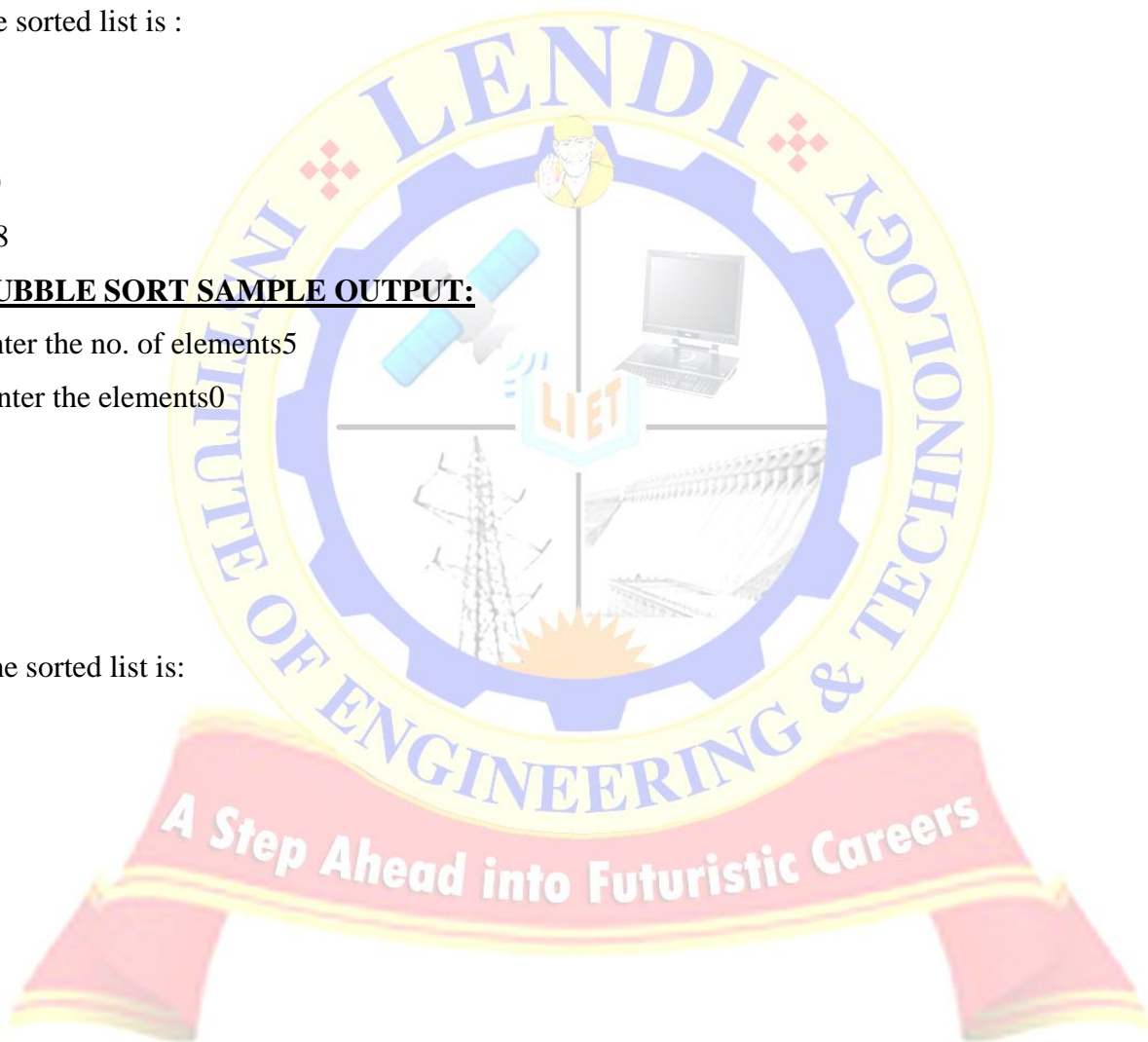

C LAB MANUAL**EXERCISE- 8C**

AIM: Write a c program to perform operations on matrices

DESCRIPTION: We can perform addition of two matrices provided their orders are same. And we can perform multiplication of two matrices if the no of columns of first matrix are equal to number of rows of second matrix.

ALGORITHM:

Matrix addition Algorithm) Suppose A and B are two matrix arrays of order $m \times n$, and C is another matrix array to store the addition result. i, j are counters.

Step1: Start

Step2: Read: m and n

Step3: Read: Take inputs for Matrix A[1:m, 1:n] and Matrix B[1:m, 1:n]

Step4: Repeat for i := 1 to m by 1:

Repeat for j := 1 to n by 1:

$C[i, j] := A[i, j] + B[i, j]$

[End of inner for loop]

[End of outer for loop]

Step5: Print: Matrix C

Step6: Exit.

ALGORITHM

(Matrix Multiplication Algorithm) Suppose A and B are two matrices and their order are respectively $m \times n$ and $p \times q$. i, j and k are counters. And C to store result.

Step1: Start.

Step2: Read: m, n, p and q

Step3: Read: Inputs for Matrices A[1:m, 1:n] and B[1:p, 1:q].

Step4: If $n \neq p$ then:

Print: Multiplication is not possible.

Else:

Repeat for i := 1 to m by 1:

Repeat for j := 1 to q by 1:

$C[i, j] := 0$ [Initializing]

C LAB MANUAL

Repeat k: = 1 to n by 1

$C[i, j] := C[i, j] + A[i, k] \times B[k, j]$

[End of for loop]

[End of for loop]

[End of for loop]

[End of If structure]

Step5: Print: C[1:m, 1:q]

Step6: Exit.

SAMPLE OUTPUT:

enter rows and colomns of two matrices 2 2

enter the first matrix 1 0 0 1

enter the second matrix 1 1 1 1

the result matrix is :

2 1

1 2

SAMPLE OUTPUT:

Enter matrix a :

Enter 1 row : 1 2

Enter 2 row : 1 2

Enter matrix b:

Enter 1 row : 1 2

Enter 2 row : 1 2

Addition of a and b:

2 4

2 4

C LAB MANUAL

Multiplication of a and b:

3 6

3 6



C LAB MANUAL**EXERCISE -9A**

AIM: Write a C Program to Store Information of a Movie Using Structure

DESCRIPTION: A structure is an user defined data type used to represent an object or entity. The information of the movie consists of Movie Name, Hero Name, Heroin Name, Director Name and Certification etc. We can use a structure to represent the information of the movie.

ALGORITHM:

1. Start
2. Declare structure with movie data
3. Read movie title
4. Read name of the movie's Director
5. Read the year the movie was released
6. Read running time of the movie in minutes
7. Read the Production Cost
8. Read First Year Revenue
9. Print movie title, movie's Director, movie was released, running time of the movie in minutes, Production Cost, First Year Revenue

SAMPLE OUTPUT:

Enter the title of the movie: Bahubali

Enter the name of the movie's Director: RajaMouli

Enter the year the movie was released: 2015

Enter the running time of the movie in minutes: 180

Enter the Production Cost: 2500000000

Enter the First Year Revenue: 2500000000

C LAB MANUAL

movie details

Bahubali

RajaMouli

2015

180

2500000000

2500000000

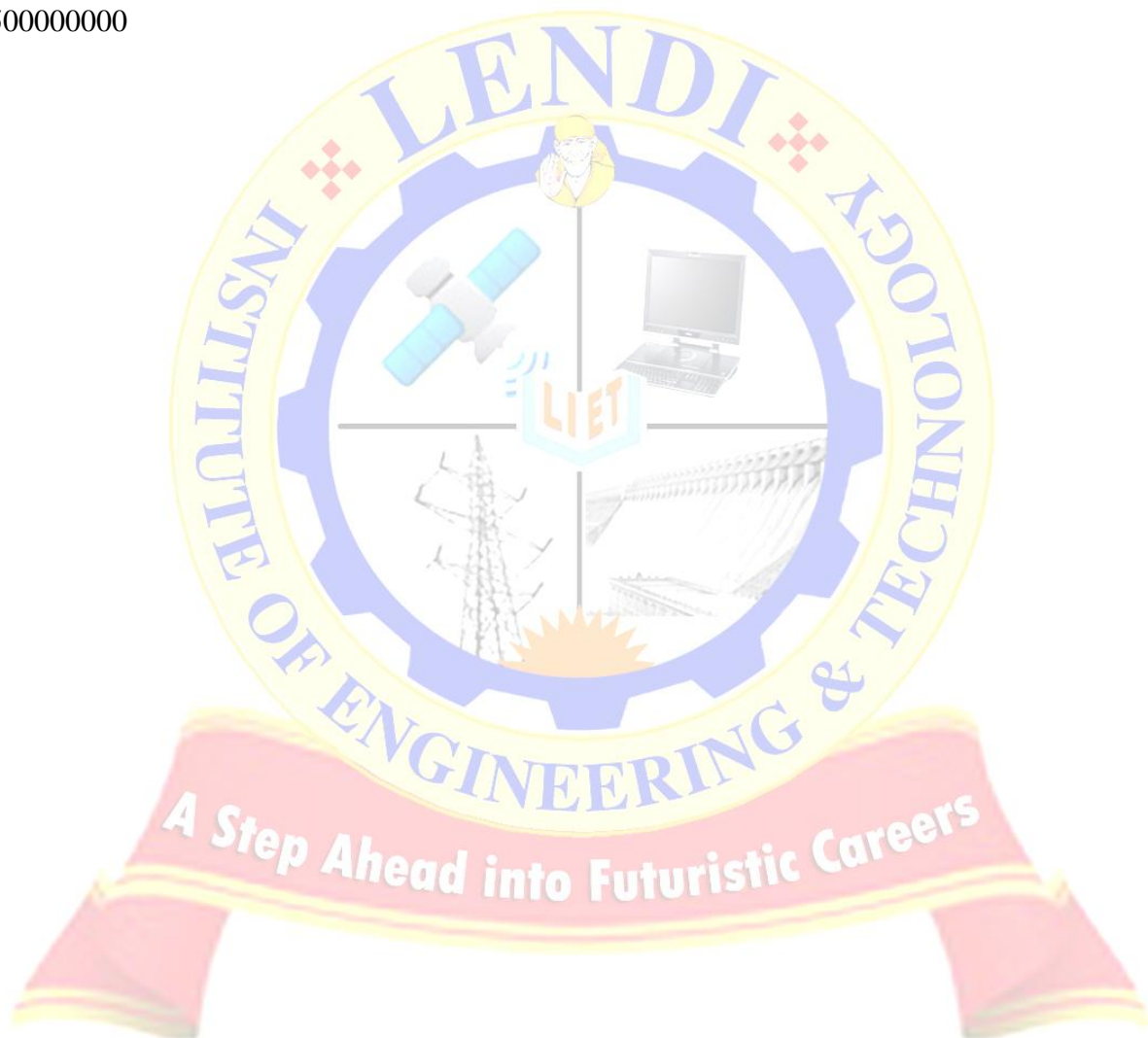

C LAB MANUAL**EXERCISE- 9B**

AIM: Write a C Program to Store Information Using Structures with Dynamically Memory Allocation

DESCRIPTION: Structure is a user-defined data type in C which allows you to combine different data types to store a particular type of record. Structure helps to construct a complex data type in more meaningful way. It is somewhat similar to an Array. The only difference is that array is used to store collection of similar data types while structure can store collection of any type of data.

Structure is used to represent a record. Suppose you want to store record of Student which consists of student name, address, roll number and age. You can define a structure to hold this information.

DEFINING A STRUCTURE

struct keyword is used to define a structure. struct define a new data type which is a collection of different type of data.

ALGORITHM:

STEP-1. Start

STEP-2. Declare the structure course

STEP-3. Declare *ptr, i, noOfRecords

STEP-4. Read number of records

STEP-5. ptr = (struct course*) malloc (noOfRecords * sizeof(struct course));

STEP-6. for(i = 0; i < noOfRecords; ++i)

6.1 read Enter name of the subject and marks respectively

STEP-7. Print Displaying Information

STEP-8. for(i = 0; i < noOfRecords ; ++i) then

STEP-9. Print (ptr+i)->subject, (ptr+i)->marks

STEP-10. Stop

SAMPLE OUTPUT:

Enter number of records: 2

Enter name of the subject and marks respectively:

C LAB MANUAL

Programming

22

Enter name of the subject and marks respectively:

Structure

33

Displaying Information:

Programming 22

Structure 33

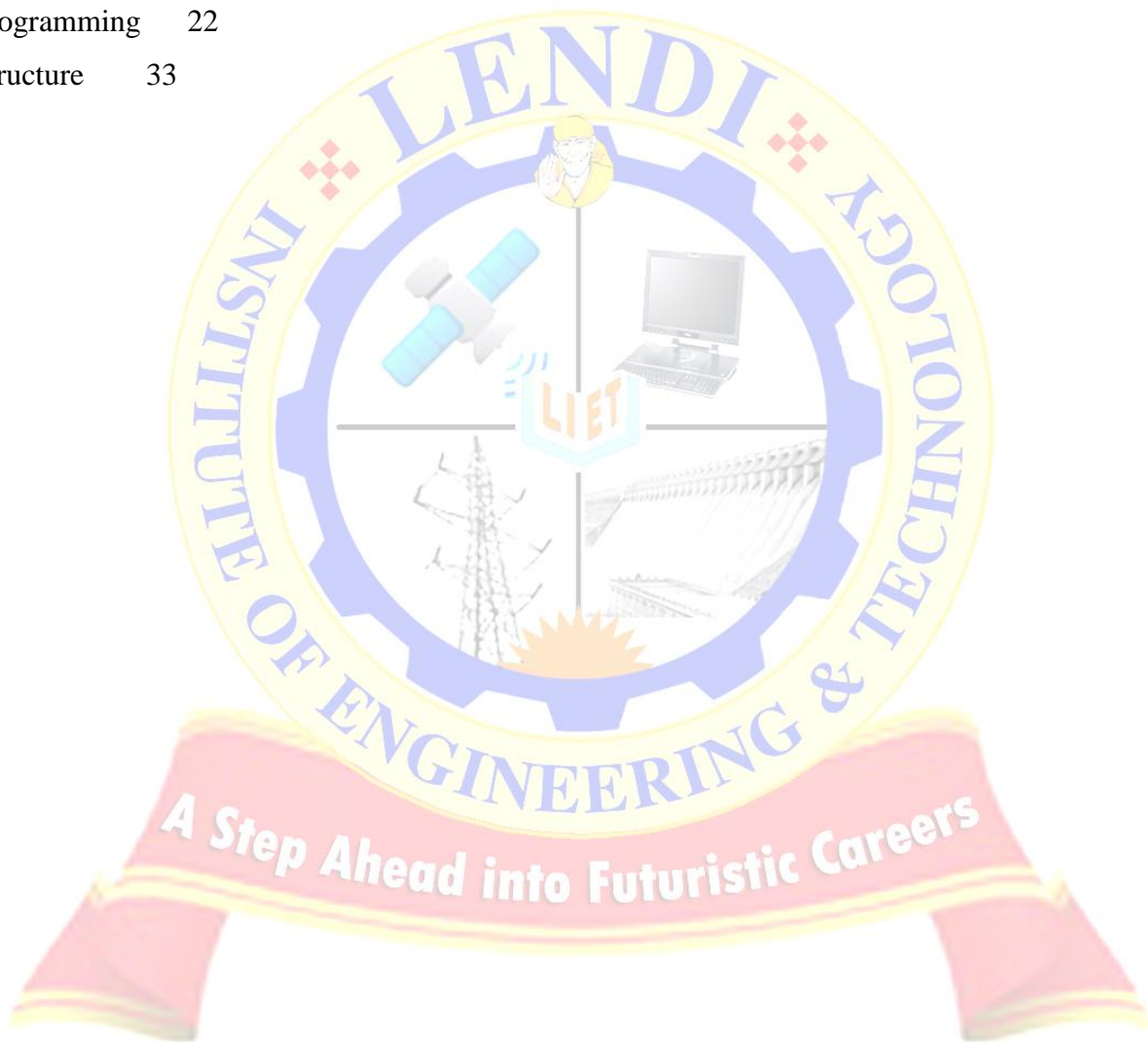

C LAB MANUAL**EXERCISE- 9C**

AIM: Write a C Program to Add Two Complex Numbers by Passing Structure to a Function

DESCRIPTION: C program to add two complex numbers: this program calculate the sum of two complex numbers which will be entered by the user and then prints it. User will have to enter the real and imaginary parts of two complex numbers. In our program we will add real parts and imaginary parts of complex numbers and prints the complex number, i is the symbol used for iota. For example if user entered two complex numbers as (1 + 2i) and (4 + 6 i) then output of program will be (5+8i). A structure is used to store complex number.

ALGORITHM:

STEP-1. Start

STEP-2. Create structure with complex

STEP-3. Declare real, imag

STEP-4. Read complex and imaginary parts

STEP-5. Print temp.real = n1.real + n2.real;

STEP-6. Print temp.imag = n1.imag + n2.imag;

STEP-7. Stop

SAMPLE OUTPUT:

For 1st complex number

Enter real and imaginary part respectively: 2.3

4.5

For 2nd complex number

Enter real and imaginary part respectively: 3.4

5

Sum = 5.7 + 9.5i

VIVA-VOCE QUESTIONS:

1. What is the Structure?
2. What is the Union?
3. What is the difference between structure and union?
4. What is the Dynamic memory Allocation?

C LAB MANUAL

5. What is the Bit Field?
6. What is the Use of typedef ?



C LAB MANUAL**EXERCISE 10(A)**

AIM: Write a C Program to Access Elements of an Array Using Pointer

DESCRIPTION: A pointer is a variable which stores the address. One can access the value at the address by using value at the address operator(*).First read the array and then assign the address of the array to a pointer and access its value using value at the address. As per C language

a[i]=*(a+i)

ALGORITHM:

INPUT: Read N Numbers using array

OUTPUT: Print N Numbers using pointers

STEP-1: Start

STEP-2: Read array a[500],n

STEP-3: Initilaize i=0

STEP-4: Loop 1(i<n)

Read a[i]

i++

Repeat loop1

STEP-5: Loop 2(i<n)

Print using pointer *(a+i)

i++

Repeat loop2

STEP-6: Stop

C LAB MANUAL**SAMPLE OUTPUT:**

\$./a.out

Enter the range : 5

Enter the elements in the array : 23 10 56 78 12

Elements in the array using pointer: 23 10 56 78 12

VIVA-VOCE QUESTIONS:

1. How we can read or print the array elements?
2. How can we represent an array using a pointer?
3. What is the difference between array and pointer?
4. Write pointer in terms of an array?
5. How can we retrieve address to an array?

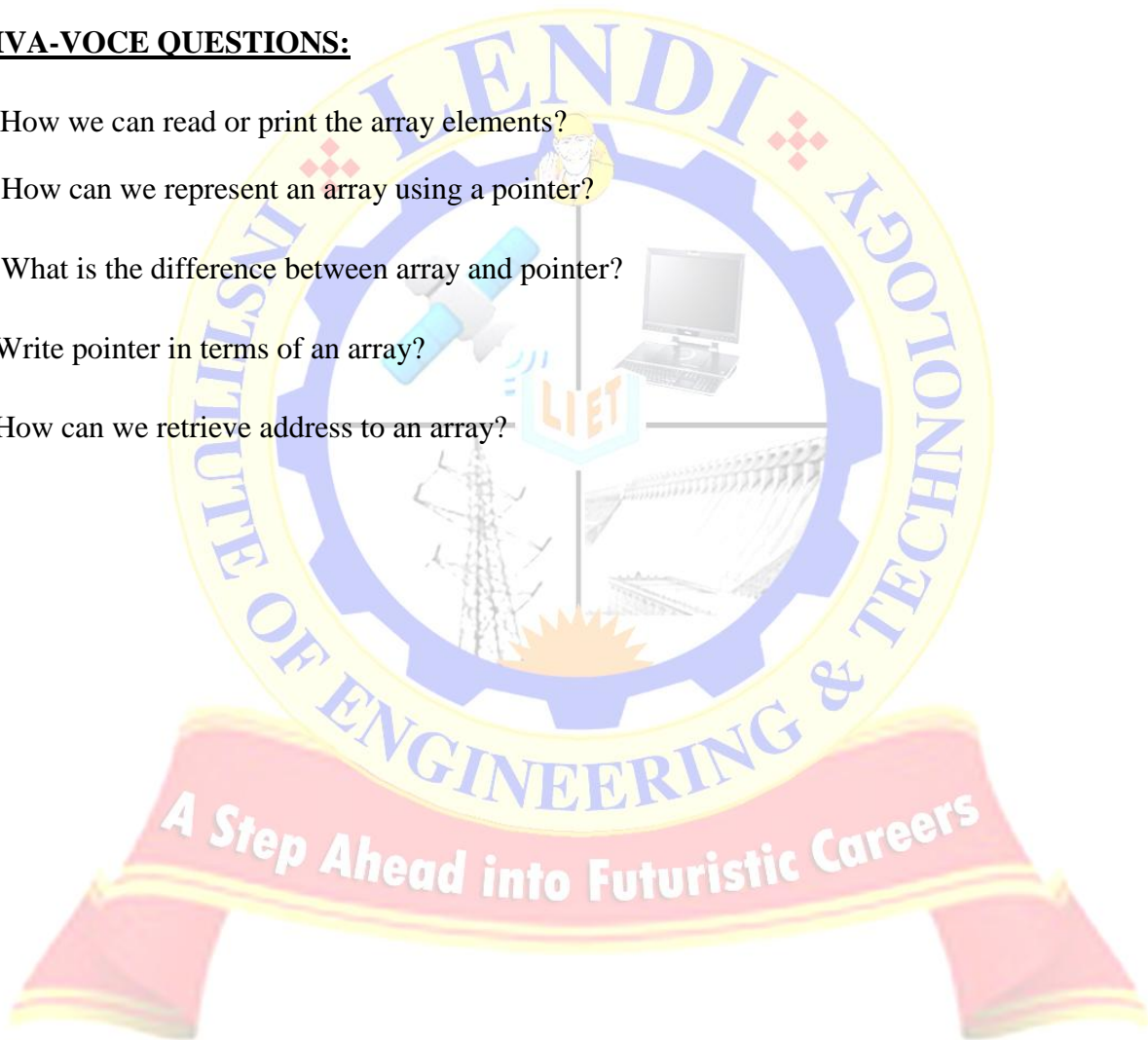

C LAB MANUAL**EXERCISE 10(B)**

AIM: Write a C Program to find the sum of numbers with Arrays and Pointers.

DESCRIPTION: First assign the address of array to a pointer. Then access the elements of the array using pointers and add them. Here we can use arrays, pointers, for loop to make the program.

ALGORITHM:

INPUT: Read N Numbers using array

OUTPUT: Print sum of N Numbers using pointers

STEP-1: Start

STEP-2: Read array a[500], pointer *p, n

STEP-3: Initialize i=0,sum=0

STEP-4: Loop 1(i<n)

Read a[i]

i++

Repeat loop1

STEP-5: Store array in pointer p=a

STEP-6: Loop 2(i<n)

Sum=sum+ *p

p++

i++

Repeat loop2

STEP-7: Display sum

STEP-8: Stop

C LAB MANUAL**SAMPLE OUTPUT:**

\$./a.out

Enter the range : 5

Enter the elements in the array : 1 2 3 4 5

The sum of elements using pointer: 15

VIVA-VOCE QUESTIONS:

1. Define Pointer with Syntax and example?
2. What is the procedure to store an array address to a pointer?
3. What are the uses of Pointers?
4. What is a pointer value and address?
5. How are Pointer Variables initialized?

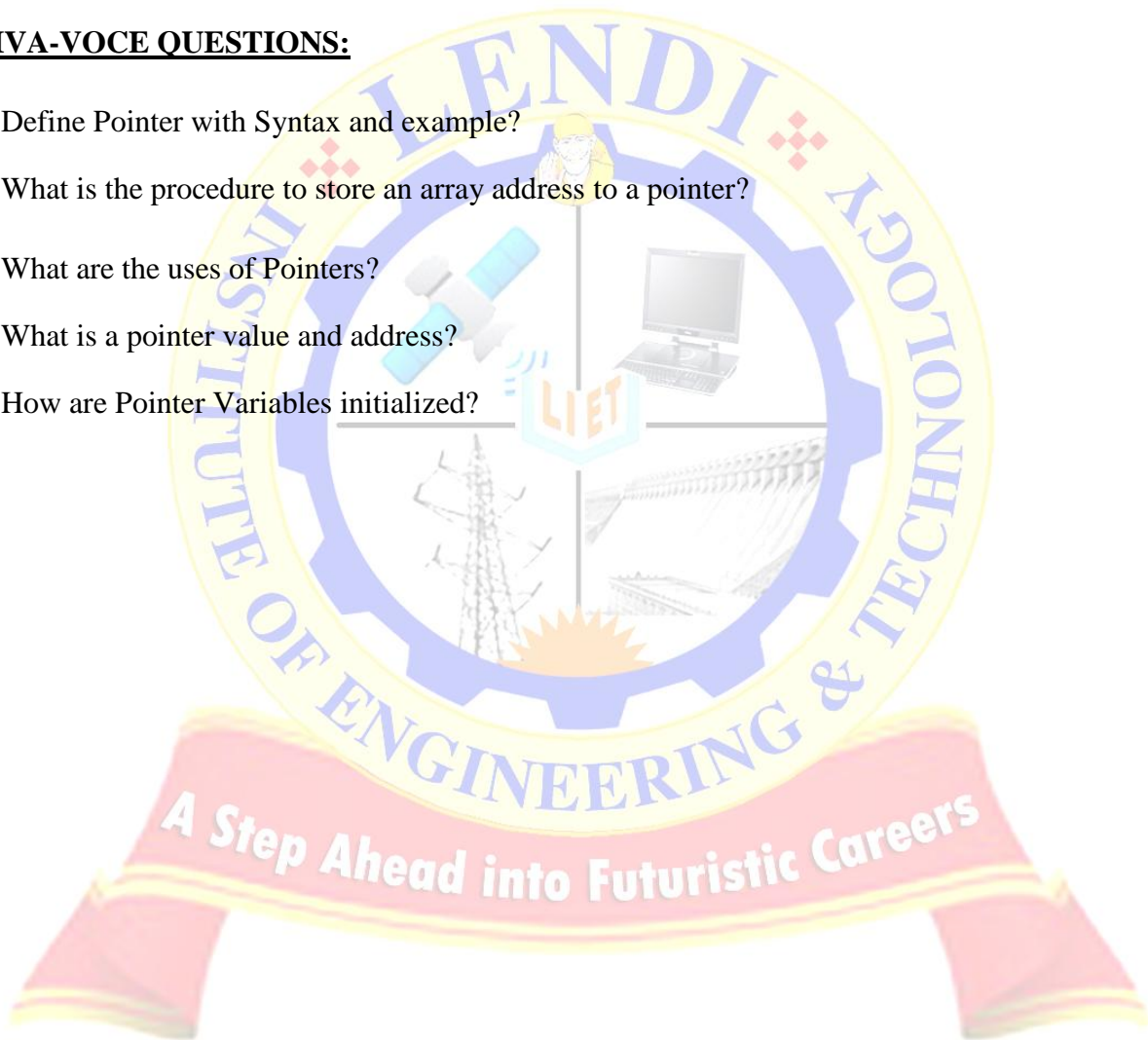

C LAB MANUAL**EXERCISE 11(A)**

AIM: Write a C program to find sum of n elements entered by user. To perform this program, allocate memory dynamically using malloc() function.

DESCRIPTION: First read the number elements then allocate memory for those many elements using dynamic memory using memory allocation function malloc() and pointers. Now we can access the elements and do summation of them.

malloc(): this is the dynamic memory allocation function used to allocate block of memory.

Header: #include<stdlib.h>

Prototype: void* malloc(int n);

ALGORITHM:

INPUT: Read N Numbers using malloc()

OUTPUT: Print sum of N Numbers using pointers

STEP-1: Start

STEP-2: Read pointer *p, n

STEP-3: Allocate p=(int*)malloc(n*sizeof(int))

STEP-4: Initilaize i=0,sum=0

STEP-5: Loop 1(i<n)

 Read p+i

 i++

 Repeat loop1

STEP-6: Loop 2(i<n)

 Sum=sum+ *p

 p++

 i++

C LAB MANUAL

Repeat loop2

STEP-7: Display sum

STEP-8: Stop

SAMPLE OUTPUT:

\$./a.out

Enter the range : 5

Enter the elements in the array : 1 2 3 4 5

The sum of elements using pointer: 15

VIVA-VOCE QUESTIONS:

1. What are the functions used in dynamic memory management?
2. What is the header file of malloc()?
3. What is the invalid pointer Arithmetic?
4. What is the purpose of free?
5. What are the pointer declarations used in C?

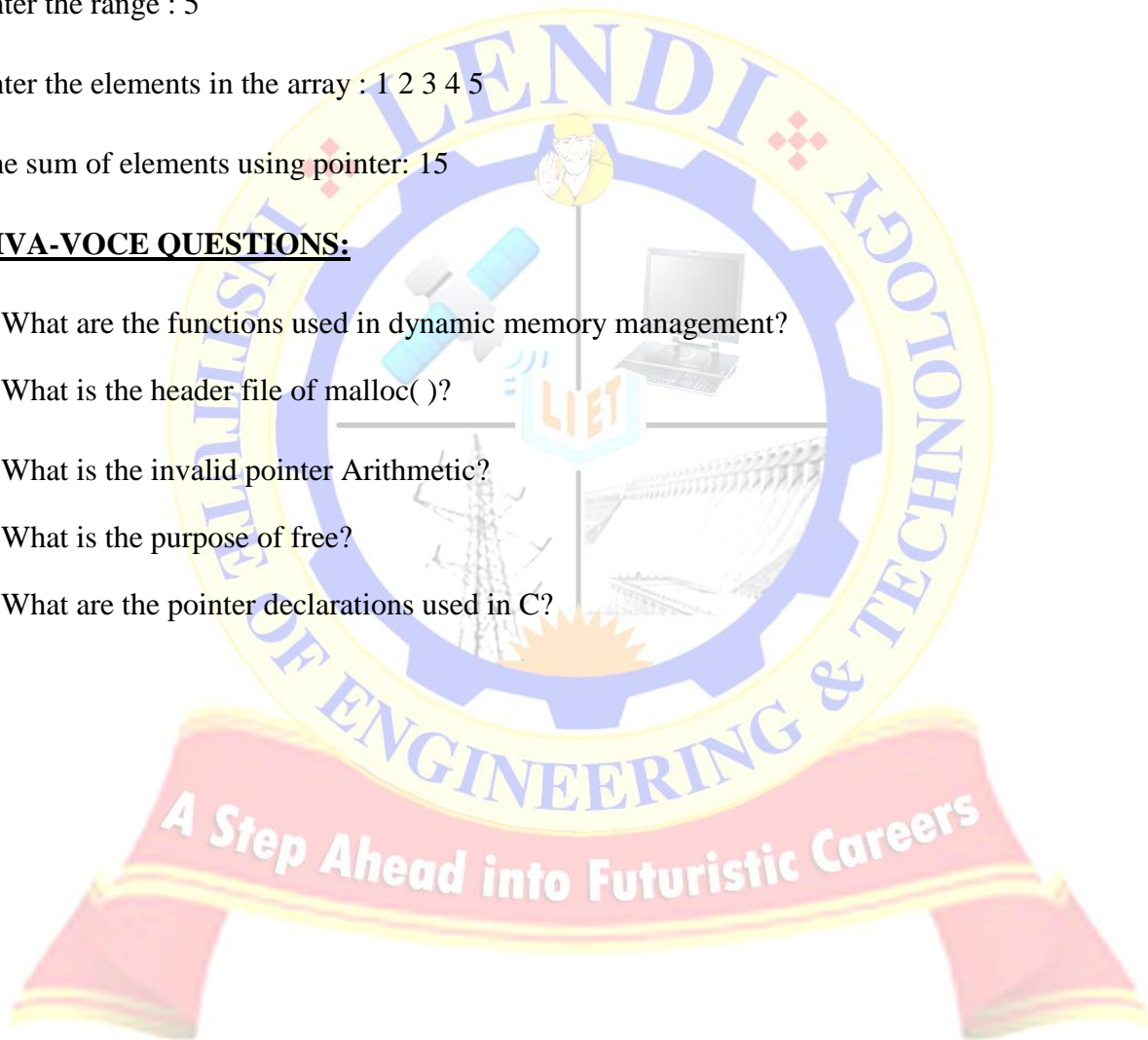

C LAB MANUAL**EXERCISE 11(B)**

AIM: Write a C program to find sum of n elements entered by user. To perform this program, allocate memory dynamically using calloc() function. Understand the difference between the above two programs.

DESCRIPTION: First read the number elements then allocate memory for those many elements using dynamic memory using memory allocation function calloc() and pointers. Now we can access the elements and do summation of them.

calloc(): this is the dynamic memory allocation function used to allocate memory to array of elements. And makes them initialized to zeros.

Header: #include<stdli.h>

Prototype: void* calloc(int n,int size);

ALGORITHM:

INPUT: Read N Numbers using calloc()

OUTPUT: Print sum of N Numbers using pointers

STEP-1: Start

STEP-2: Read pointer *p, n

STEP-3: Allocate p=(int*)calloc(n,sizeof(int))

STEP-4: Initilaize i=0,sum=0

STEP-5: Loop 1(i<n)

 Read p+i

 i++

Repeat loop1

STEP-6: Loop 2(i<n)

 Sum=sum+ *p

 p++

C LAB MANUAL

i++

Repeat loop2

STEP-7: Display sum

STEP-8: Stop

SAMPLE OUTPUT:

\$./a.out

Enter the range : 5

Enter the elements in the array : 1 2 3 4 5

The sum of elements using pointer: 15

VIVA-VOCE QUESTIONS:

1. What is the difference between malloc() and calloc() Functions?
2. What is the header file of calloc()?
3. What is pointer address Arithmetic?
4. What is the purpose of realloc?
5. What is a pointer to pointer?

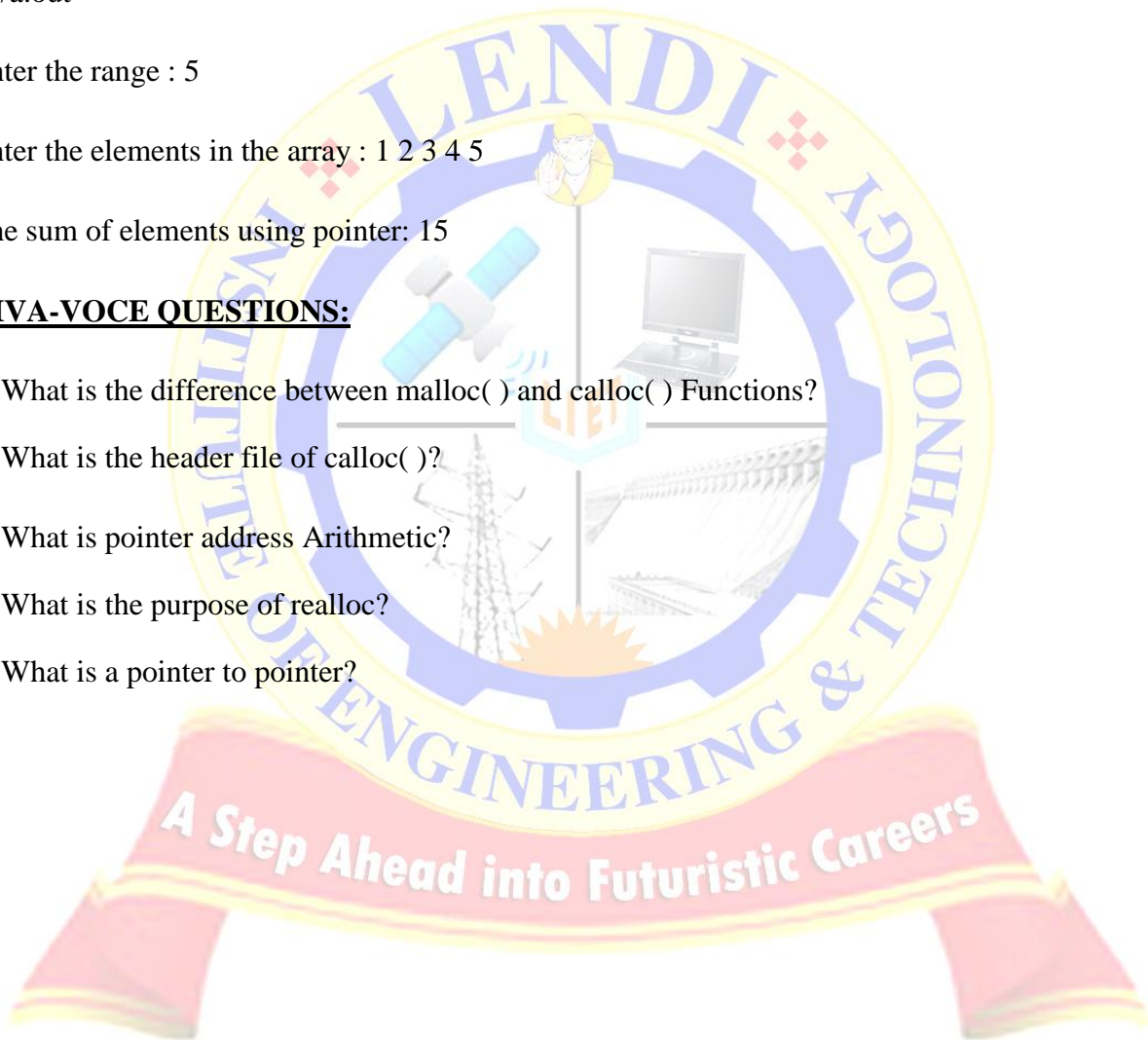

C LAB MANUAL**EXERCISE 12(A)**

AIM: Implementation of string manipulation operations with library function.

Copy
Concatenate
Length
Compare

DESCRIPTION: : The string library consists of strcpy(), strcat(), strlen(), strcmp() functions

Copy: It is used copy one string to the other.

Header: #include<string.h>

Prototype: strcpy(char* destination,char* source)

Concatenate: The string library consists of strcat() function which is used to concatenate or combine one string with the other.

Header: #include<string.h>

Prototype: strcat(char* source,char* destination)

In the above destination is appended to the source.

Length: Length of the string is the number of characters in the string.The string library consists of strlen() function which is used to get length of the string.

Header: #include<string.h>

Prototype: int strlen(char* string)

Returns : Length of the string.

String Comparission: The string library consists of strcmp() function which is used to compare two strings and results their relation.

Header: #include<string.h>

Prototype: int strcmp(char* source,char* destination)

C LAB MANUAL

Return Value: Returns 0 if they are equal

Otherwise returns ascii difference between characters where they differ.

ALGORITHM:

INPUT: 3 Strings

OUTPUT: Copied String, String length, Concatenated String and Compared Strings

STEP-1: Start

STEP-2: Read s1,s2,s3

STEP-3: Compute l1= strlen(s1)

STEP-4: Print l1

STEP-5: Compute s=strcpy(s3,s1)

STEP-6: Print s

STEP-7: Compute e= strcmp(s1,s2)

STEP-8: if e==0 go to step 9 otherwise go to step 10

STEP-9: Display “strings are equal”

STEP-10: Display “Strings are not equal”

STEP-11: Display “after concatenation of two strings s1 and s2 is “ strcat(s1,s2)

STEP-12: Stop

SAMPLE OUTPUT:

\$./a.out

Enter three strings

C LAB MANUAL

Lendi

Engineering

College

Length of s1 is 5

After copying 1st string into 3rd string is Lendi

The two Strings s1 and s2 are not equal

After adding first two string LendiEngineering

VIVA-VOCE QUESTIONS:

1. Define a String?
2. Header used for String Functions?
3. List String Handling Functions or String Manipulation Functions?
4. What is the return type of strcmp() and strlen()?
5. How many arguments are there in strcat() and strcpy() functions?

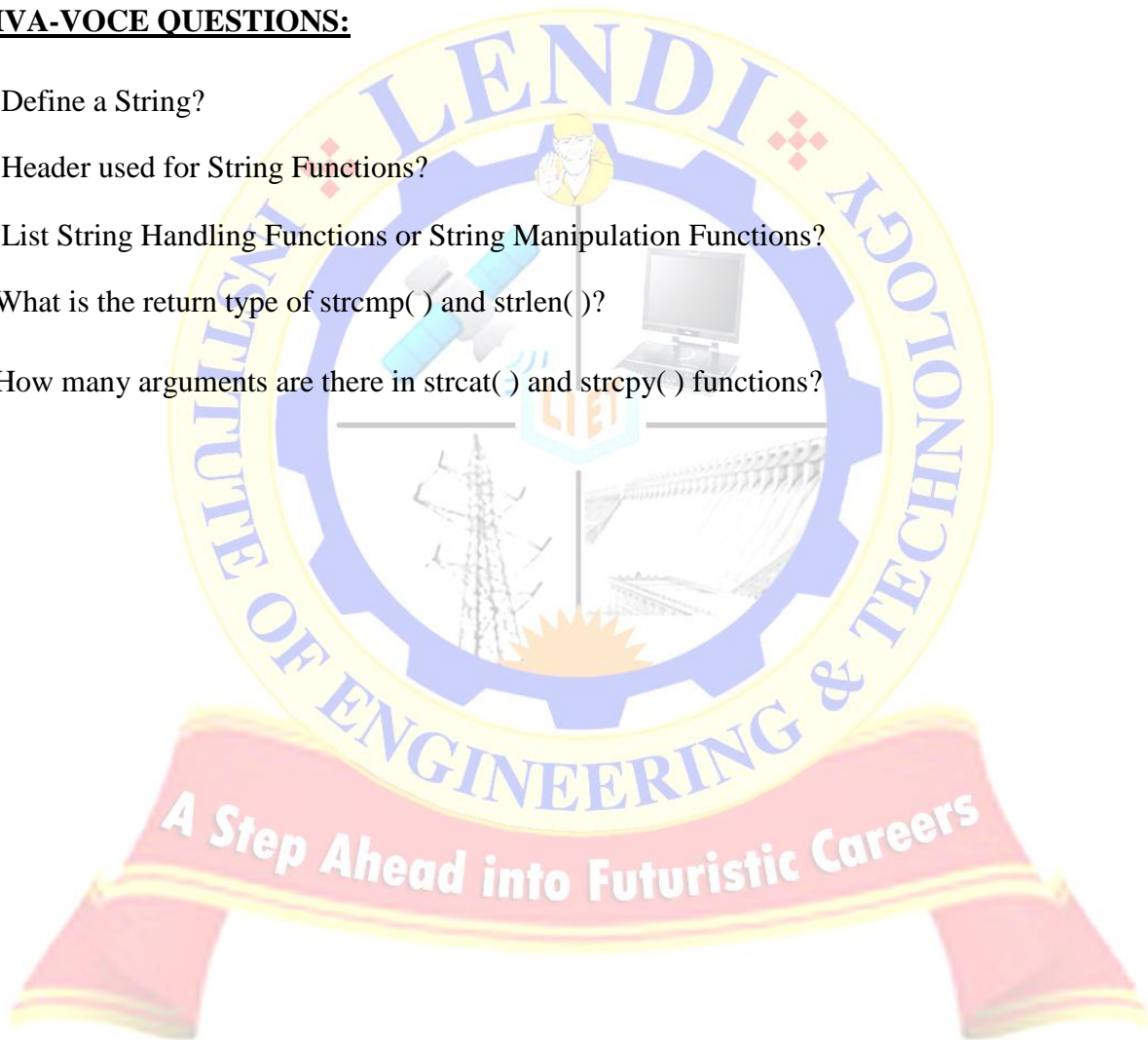

C LAB MANUAL**EXERCISE 12(B)**

AIM: Implementation of string manipulation operations without using library function.

Copy
Concatenate
Length
Compare

DESCRIPTION: :

Copy: As the string terminates with the null character('\0') take each character from the first string until you get null character and make it copied to corresponding position of the second string. So that the strings are copied.

ALGORITHM:

INPUT: 1 String

OUTPUT: Copied one String to other.

STEP-1: Start

STEP-2: Read a string s1

STEP-3: Initialize i=0

STEP-4: If s1[i]!='\0' then

s2[i]=s1[i]

Increment i

STEP-5: Otherwise s2[i]='\0'

STEP-6: Print s2

STEP-7: Stop

C LAB MANUAL**SAMPLE OUTPUT:**

```
$ ./a.out
```

```
Enter a string : malayalam
```

```
The copied string is malayalam
```

Concatenate: String concatenation is appending second string at the end of first string. First reach end of the first string from where copy second string into first string.

ALGORITHM:

INPUT: 2 Strings

OUTPUT: Two Strings will Append

STEP-1: Start

STEP-2: Read strings s1,s2

STEP-3: Initilaize i=0, j=0

STEP-4: Loop 1(s1[i]!='\0')

i++

Repeat loop1

STEP-5: Loop2 (s2[j]!='\0')

s1[i]=s2[j]

i++

j++

Repeat loop2

STEP-6: s1[i]='\0'

STEP-7: Display s1

STEP-8: Stop

C LAB MANUAL**SAMPLE OUTPUT:**

\$./a.out

Enter string a: rose

Enter string b: flower

The edited string is: roseflower

Length: Length of the string is the number of characters in the string. Scanning the string character by character and make the count until you get null character.

ALGORITHM:

INPUT: 1 String

OUTPUT: Length of the String

STEP-1: Start

STEP-2: Initialize len=0

STEP-3: Read the string s1

STEP-4: Initialize I=0

STEP-5: If s1[i]!='\0' otherwise go to

STEP-6: Increment len

STEP-7: Display len

STEP-8: Stop

SAMPLE OUTPUT:

\$./a.out

Enter a string : malayalam

The length of the string is 9

C LAB MANUAL

String Comparission: If the lengths of the strings are same then we can go for comparison of them. Such that the strings are compared character by character until end or there is no match.

ALGORITHM:

INPUT: 2 Strings

OUTPUT: Compare two Strings

STEP-1: Start

STEP-2: Read strings s1,s2

STEP-3: Initilaize i=0,temp=0

STEP-4: Loop 1(s1[i]!='\0' || s2[i]!='\0')

 If(s1[i] != s2[i])

 temp=i

 i++

 Repeat loop1

STEP-5: If (temp= i)

 Display the two strings are equal

STEP-6: Otherwise

 Display the two strings are not equal

STEP-7: Stop

SAMPLE OUTPUT:

\$./a.out

Enter the string1 : malayalam

Enter the string2 : malayalam

The two strings are equal

C LAB MANUAL**VIVA-VOCE QUESTIONS:**

1. What is the difference between strings and arrays?
2. What is \0 in a string?
3. What is null character in a string?
4. What is the meaning of character array?
5. What is the difference between character array and integer array?

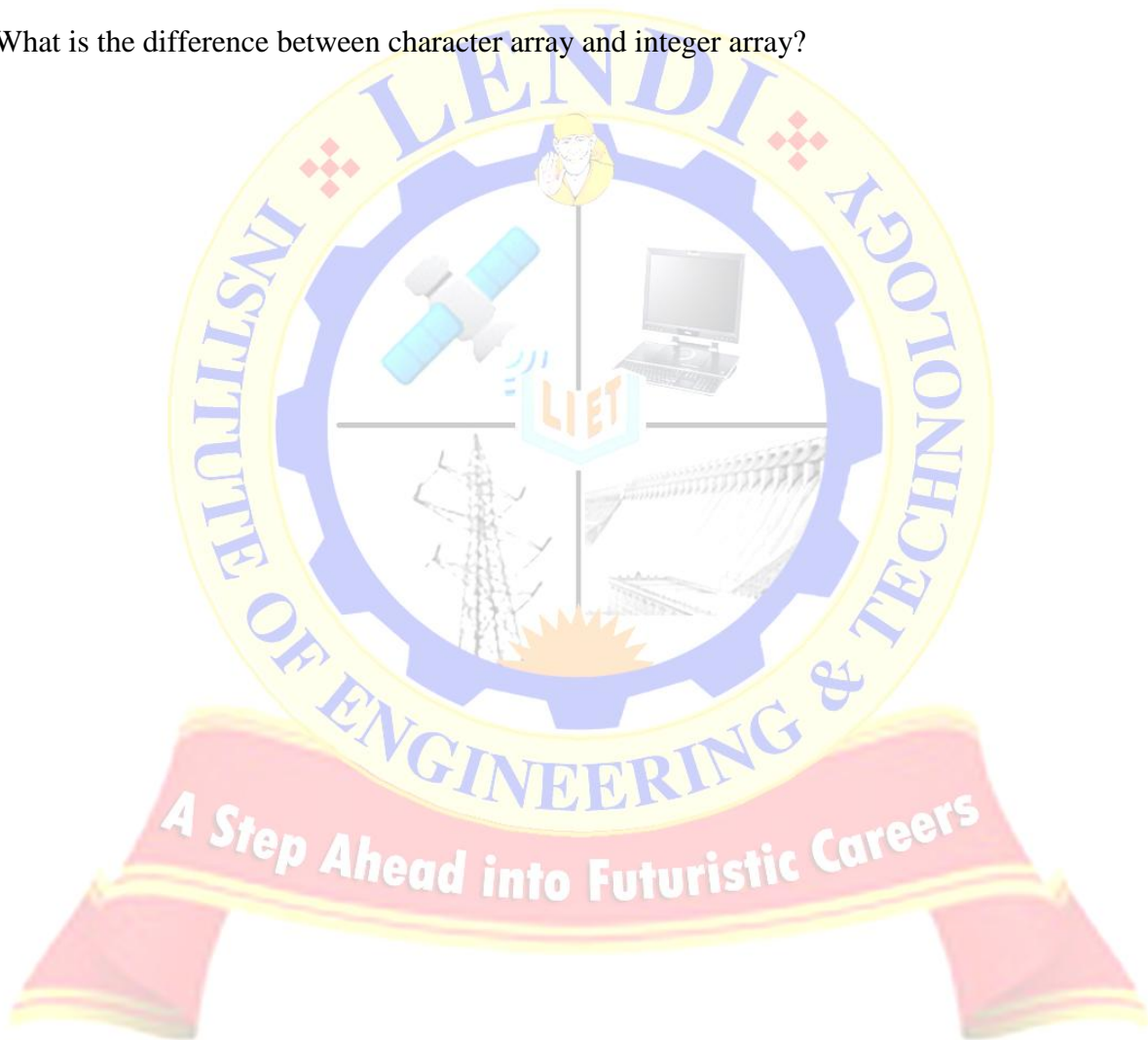

C LAB MANUAL**EXERCISE 13(A)**

AIM: Write a C programming code to open a file and to print its contents on screen.

DESCRIPTION: It is the program to display the content of the file. First open the file using `fopen()` and read the file character by character using `fgetc()` until end of the file is reached and after reading characters display them using `printf()`.

fopen(): This is the function to open a file.

Header: `#include<stdio.h>`

Prototype: `FILE* fopen(char* fname,char* mode)`

Return: On success return FILE pointer and On failure returns NULL.

fgetc(): Used to read a character from an opened file.

Header: `#include<stdio.h>`

Prototype: `int fgetc(FILE* fp)`

Return: On success returns next character and EOF on error or end of the file.

ALGORITHM:

INPUT: One file

OUTPUT: Displaying the file content.

STEP-1: Start

STEP-2: Read filename for source

STEP-3: Open source file in read mode into fp

STEP-4: If fp equal to NULL then

Display file not opened, go to step 8

Else

C LAB MANUAL

Loop (char= fgetc(fp1)) != EOF)

Display char

repeat Loop

STEP-6: Close file pointer (fp)

STEP-7: Stop

SAMPLE OUTPUT:

\$./a.out

Enter the file : x.txt

The content of the file

This is my first file handling program.

VIVA-VOCE QUESTIONS:

1. What is the file mode to read a file?
2. What is the header file of file handling functions?
3. Give the syntax to open a file?
4. What is the usage of fgetc() function?
5. What is EOF?

C LAB MANUAL**EXERCISE 13(B)**

AIM: Write a C program to copy files.

DESCRIPTION: This is the program to copy file content in to another file. Open the first file in read mode and second file in write mode. Read first file character by character using `fgetc()` until end of the file and write the read character into second file using `fputc()`.

fputc(): This is the function used to write a character into an opened file.

Header: `#include<stdio.h>`

Prototype: `int fputc(char ch,FILE* fp)`

Return: On success return character written and On failure returns EOF.

ALGORITHM:

INPUT: Two files source and destination

OUTPUT: Source file content are copied to destination file

STEP-1:Start

STEP-2:Read filename for source

STEP-3:Read filename for destination

STEP-4:Open source file in read mode into fp1

STEP-5: Open destination file in write mode into fp2

STEP-6: If fp1 or fp2 equal to NULL then

Display file not opened, go to step 9

Else

Loop (`char= fgetc(fp1) != EOF`)

`fputc(char, fp2)`

C LAB MANUAL

repeat Loop

STEP-7:Close file pointer(fp1)

STEP-8:Close file pointer (fp2)

STEP-9:Stop

SAMPLE OUTPUT:

\$./a.out

Enter the file1: source.c

Enter the file2: Destination.c

Contents are successfully copied.

VIVA-VOCE QUESTIONS:

- 1.What is the file mode to write a file?
2. What are the file management functions available in C
3. Give the syntax to close a file?
- 4.What is the usage of fputc() function?
- 5.What is the difference between text file and binary file?

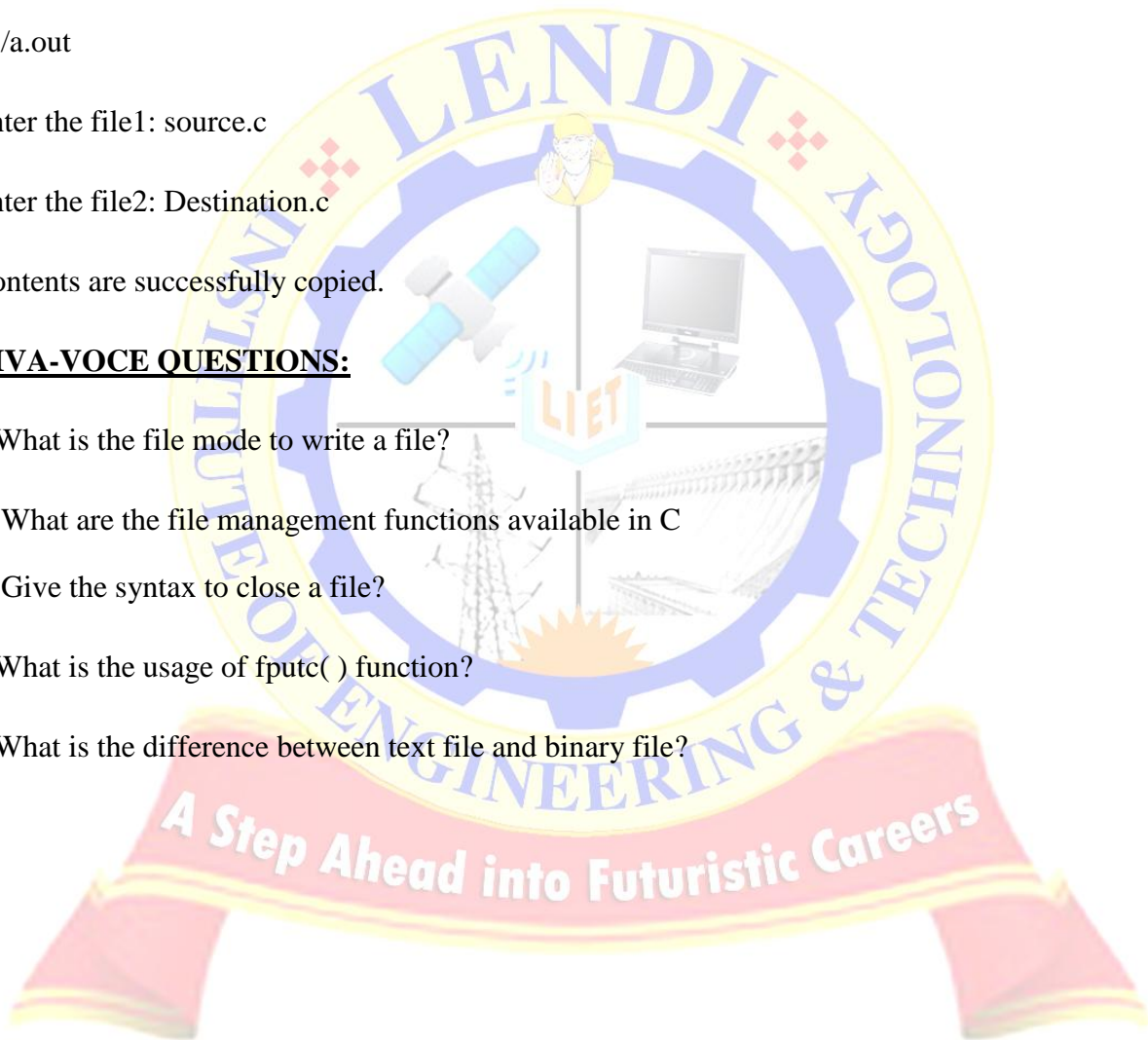

C LAB MANUAL**EXERCISE 14(A)**

AIM: Write a C program merges two files and stores their contents in another file.

DESCRIPTION: The process of combining two files into third file is said as merging the files. First open first two files in read mode and third file in write mode. Then Copy first file content into to third file followed by second file.

ALGORITHM:

INPUT: Three files source1, source2 and destination

OUTPUT: Source files content are merged into destination file

STEP-1:Start

STEP-2:Read filename for source 1

STEP-3: Read filename for source 2

STEP-4:Read filename for destination

STEP-5: Open source file 1 in read mode into fp1

STEP-6: Open source file 2 in read mode into fp2

STEP-7: Open destination file in write mode into fp3

STEP-8:

If fp1 or fp2 or fp3 equal to NULL then

Display file not opened, go to step 12

Else

Loop 1 (char= fgetc(fp1)) != EOF)

fputc(char, fp3)

Repeat Loop1

C LAB MANUAL

Loop 2 (char= fgetc(fp2)) != EOF)

fputc(char, fp3)

Repeat loop2

STEP-9:Close file pointer(fp1)

STEP-10:Close file pointer (fp2)

STEP-11: Close file pointer (fp3)

STEP-12: Stop

SAMPLE OUTPUT:

\$./a.out

Enter the file1: source1.c

Enter the file2: source2.c

Enter the file3: Destination.c

Contents are successfully merged in destination file.

VIVA-VOCE QUESTIONS:

- 1.What is the file mode to append a file?
2. What are the file modes in C?
3. What are the different types of files?
- 4.How many arguments are there in fopen() function and explain?
- 5.What is the function to close all files?

C LAB MANUAL**EXERCISE 14(B)**

AIM: Write a C program to delete a file.

DESCRIPTION: Deleting a file means removing the file. This can be done using `remove ()`.

remove (): This is the function used to delete a file.

Header: `#include<stdio.h>`

Prototype: `int remove(char * filename)`

Return Value: On success zero and -1 on failure

ALGORITHM:

INPUT: Path of the file to be deleted

OUTPUT: A message whether the file is deleted or not.

STEP-1:Start

STEP-2: Read file path in p

STEP-3: Display file path

STEP-4: `x= remove (p)`

STEP-5: If `(x==0)`

Display file is deleted successfully

Otherwise

Display file deletion error

STEP-6:Stop

SAMPLE OUTPUT:

\$./a.out

C LAB MANUAL

Enter the file: x.txt

File is deleted successfully

VIVA-VOCE QUESTIONS:

- 1.What is the function to delete a file?
2. What is the header file of remove() function?
3. What is the error function in files?
- 4.How many arguments are there in remove() function and explain?
- 5.What is the return type of remove() function?

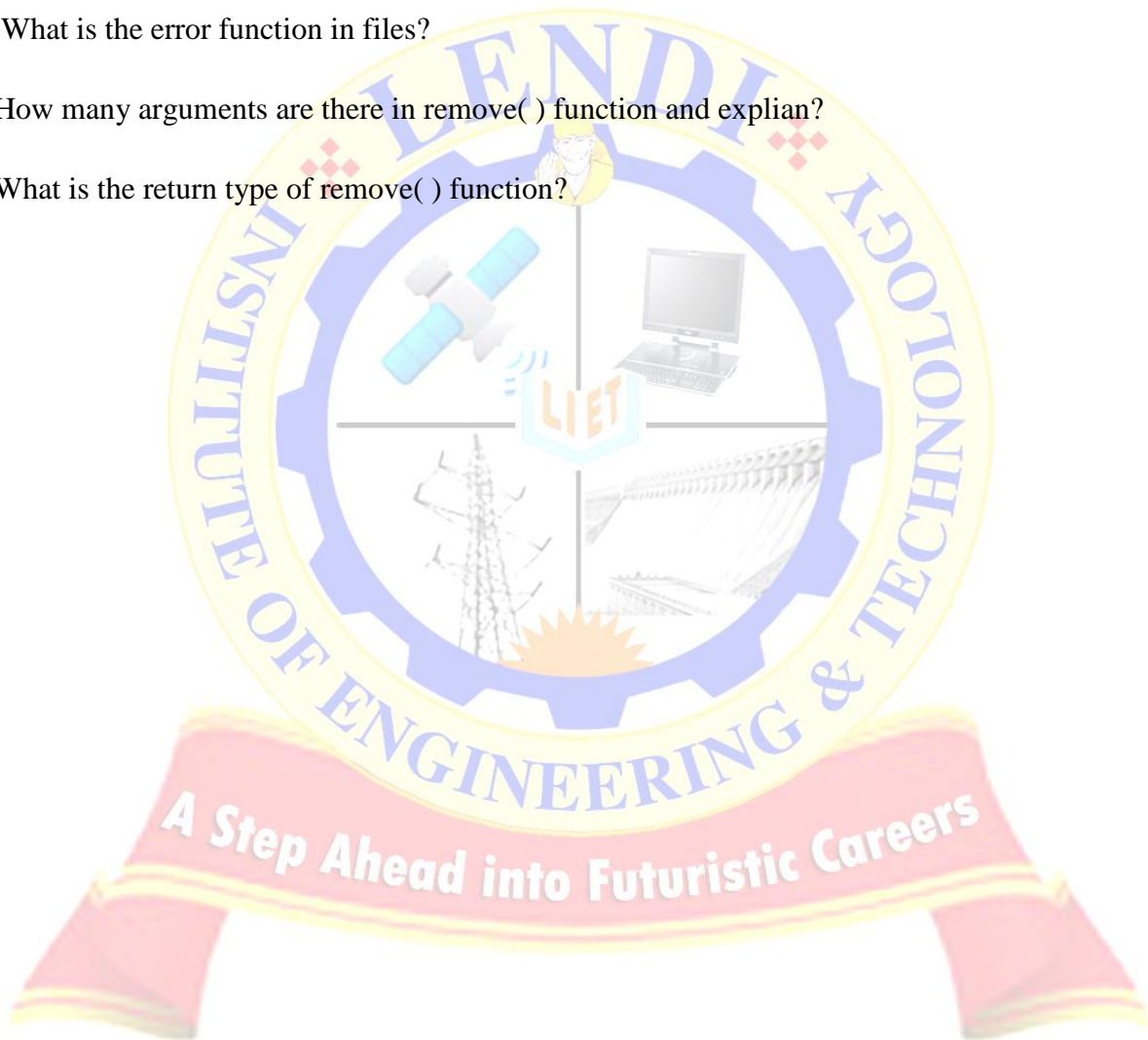

C LAB MANUAL

EXERCISE 15(A)

AIM: System Assembling, Disassembling and identification of Parts / Peripherals

INTRODUCTION TO COMPUTER:

Computer is an electronic device which takes the input information from the input device and generates the output information and it will be displayed on the output. It enables arithmetic computations, data processing, information management (storage) and knowledge reasoning in an efficient manner. The word computer is derived from the word **compute** which means „to **calculate**. So a computer generally considered to be calculating device that perform operations at very faster rates.

BLOCK DIAGRAM OF COMPUTER

BLOCK DIAGRAM OF COMPUTER

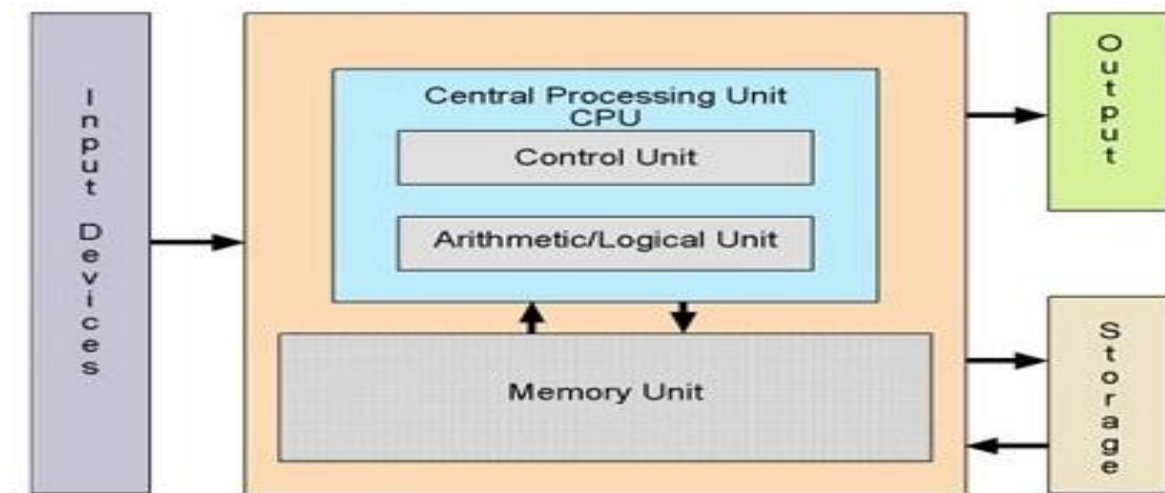

Basically the computer system has three major components. These are

- System Unit
 - ✓ Central Processing Unit (Processor)

C LAB MANUAL

- ✓ Memory Unit. (Main memory and Auxiliary storage).
- Input Unit.
- Output Unit

INPUT UNIT

This unit contains devices with the help of which we enter data into computer. This unit makes link between user and computer. The input devices translate the information into the form understandable by computer.

CPU (CENTRAL PROCESSING UNIT)

CPU is considered as the brain of the computer. CPU performs all types of data processing operations. It stores data, intermediate results and instructions (program). It controls the operation of all parts of computer.

CPU itself has following three components

- ALU(Arithmetic Logic Unit)
- Memory Unit
- Control Unit

ALU (ARITHMETIC LOGIC UNIT)

This unit consists of two subsections namely

- Arithmetic section
- Logic Section

Arithmetic Section

Function of arithmetic section is to perform arithmetic operations like addition, subtraction, multiplication and division. All complex operations are done by making repetitive use of above operations.

Logic Section

Function of logic section is to perform logic operations such as comparing, selecting, matching and merging of data.

C LAB MANUAL

MEMORY OR STORAGE UNIT

- It stores all the data and the instructions required for processing.
- It stores intermediate results of processing.
- It stores final results of processing before these results are released to an output device.
- All inputs and outputs are transmitted through main memory (RAM).

CONTROL UNIT

- It is responsible for controlling the transfer of data and instructions among other units of a computer.
- It manages and coordinates all the units of the computer.
- It obtains the instructions from the memory, interprets them, and directs the operation of the computer.
- It communicates with Input / Output devices for transfer of data or results from storage.
- It does not process or store data.

OUTPUT UNIT:

Output unit consists of devices with the help of which we get the information from computer. This unit is a link between computer and users. Output devices translate the computer's output into the form understandable by users.

ROM AND RAM

A ROM chip is non-volatile storage and does not require a constant source of power to retain information stored on it. When power is lost or turned off, a ROM chip will keep the information stored on it. A RAM chip is volatile and requires a constant source of power to retain information. When power is lost or turned off, a RAM chip will lose the information stored on it. Other differences between a ROM and a RAM chip include:

- A ROM chip is used primarily in the start up process of a computer, whereas a RAM chip is used in the normal operations of a computer after starting up and loading the operating system.
- Writing data to a ROM chip is a slow process, whereas writing data to a RAM chip is a faster process. A RAM chip can store multiple gigabytes (GB) of data, up to 16 GB or

C LAB MANUAL

more per chip. A ROM chip typically stores only several megabytes (MB) of data, up to 4 MB or more per chip.

AIM: To identify the peripherals of a computer.

Hardware is the physical appearance of the devices or tools. It is what which we can touch and feel. Computer Hardware consists of the Monitor, CPU, Keyboard, Mouse and all other devices connected to the computer either externally or internally. A typical computer (personal computer, PC) consists of a desktop or tower case (chassis) and the following parts:

1. Cabinet:

- a. It is used to install all hardware devices like (mother board, SMPS, HDD, CD ROM, FDD)
- b. It has Start, Restart Button, Led's, Audio and USB Connectors are available at front side.



2. Monitor:

- a. Monitor of a computer is like a television screen.
- b. It displays text characters and graphics in colors or in shades of grey.
- c. The monitor is also called as screen or display or CRT (cathode ray tube).

In the monitor the screen will be displayed in pixels format.

- i. 800 by 600 pixels
- ii. 1024 by 768 pixels



3. Key Board:

- a. Key board is like a type writer, which contains keys to feed the data or information into the computer
- b. Keyboards are available in two modules. These are
 - i. standard key board with 83-88 keys
 - ii. Enhanced key board with 104 keys or above



4. Mouse:

- a. Every mouse has one primary button (left button) and one secondary button (right button).



C LAB MANUAL

b. The primary button is used to carry out most tasks, where as secondary button is used in special cases you can select commands and options.

5. Printer:

a. A device that prints images (numbers, alphabets, graphs, etc...) on paper is known as Printer.

b. We have different types of printers to take printouts. These are as follows:

i. Dot matrix printer

ii. Inkjet printer

iii. Laser printer



6. Speakers:

a. Speakers make your system much more delightful to use entertain you while you are working on computer



7. Scanner :

a. Scanner used to scan images and text



8. System board/Motherboard

a. This is the major part of the PC hardware

b. It manages all transactions of data between CPU peripherals.

c. which holds the Processor, Random Access Memory and other parts, and has slots for expansion cards

d. It is rectangle shape

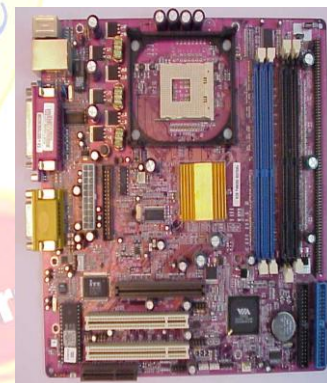

9. Socket 478:

a. It use 478 – PIN MICROPGA package it is used installing CPU

b. It is square type design.

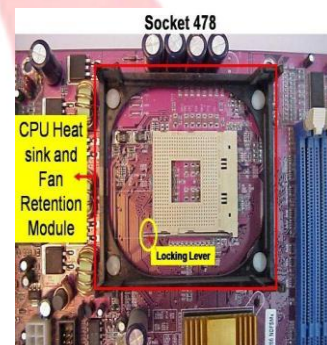

C LAB MANUAL

10. CPU

- a. The central processing unit contains the heart of any computer, the processor. The processor is fitted on to a Mother Board. The Mother Board contains various components, which support the functioning of a PC.
- b. It is brain of the computer
- c. It is square shape



11. Ram Slots and Rams:

- a. Ram slots are used to install the rams
- b. It is large rectangle shape and each ending has small clips.
- c. There two type ram slots
- d. SD Ram;-----□ Two Gaps
- e. DDR Ram;-----□ One Gap

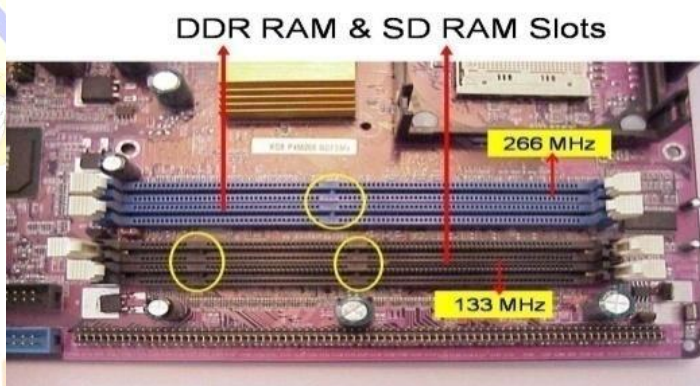

12. North Bridge:

- a. It is also called as controller
- b. It converts electronic signals to binary values and binary values to electronic signals
- c. It is near by socket 478
- d. It placed middle of the mother board

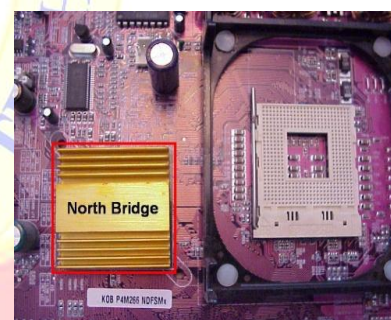

13. South Bridge:

- a. It controls major components mother board and it back bone of the input out devices
- b. It is communicates PCI slots, IDE-1, IDE-2, floppy connector, BIOS chip.
- c. It near by CMOS battery



C LAB MANUAL

14. CMOS Battery:

- a. Computer is using a coin shape battery
- b. It generates the clock signal and it manage system continues time



15. Primary & Secondary(IDE-1 & IDE-2) :

- a. It is also called as IDE-1, IDE-2.
- b. It used to connecting Hard Disk Drive, CD ROM, DVD ROM

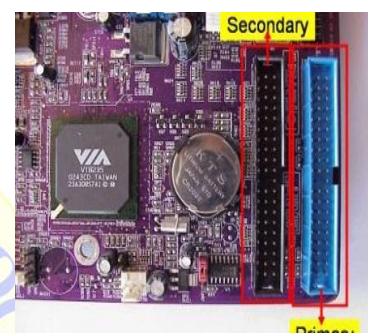

16. Input & Out put ports :

- a. IO ports are used to connecting IO device such as key boards, mouse, monitor, printer, scanner, speakers etc...

Ports (Front View)

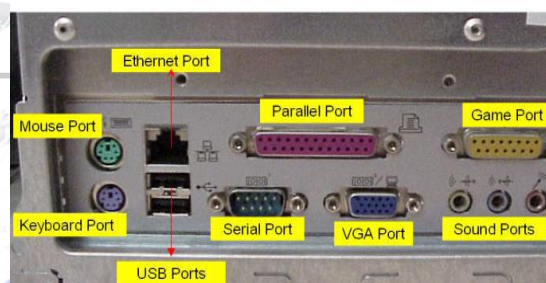

17. AGP Slot & AGP Card :

- a. AGP Slot is used install the AGP card.
- b. AGP back view same as VGA port(15-female pins) and used to connecting the monitors
- c. This slot is above PCI slots and its color is Black or Brown



18. CI Slots &PCI(Expansion) Cards :

- a. PCI slots are used to install the PCI cards such as
 - i. LAN (Ethernet) Card---□ Back view Ethernet port
 - ii. Sound Card-□ Back view Audio pin connectors)



C LAB MANUAL

- iii. TV Tuner(Internal) Card - □ Dish Pin connector
- b. PCI Slots are white or yellow color
- c. PCI Card has Single gap only



19. BIOS Chip :

- a. BIOS controls how the operating system and hardware work together
- b. BIOS identification is BIOS name is available on chip or mother board

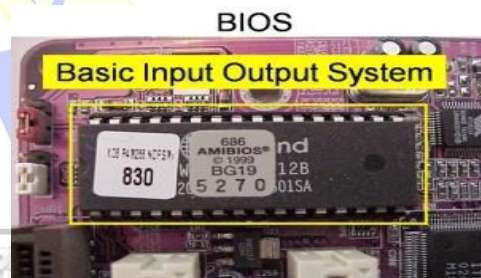

20. ATX Power connector:

- a. ATX power connector is used to connect ATX power plug(This is from SMPS)
- b. ATX Power connector has 20/24 pins available.
- c. It is white color and it has ATX name is available on Mother Board

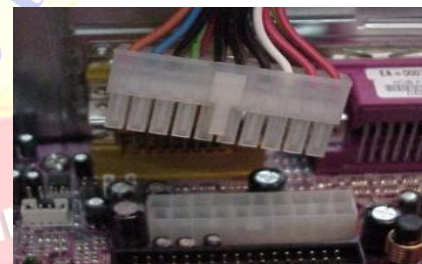

21. Floppy connector:

- a. Floppy connector is used to connect Floppy Disk Drive.
- b. This is beside of ATX power connector and Name FDD is available on the mother board.



C LAB MANUAL

22. Bus Cables or Data cables :

- a. A Bus is a collection of wires through which data is transmitted from one device to another device cables are two types
- b. IDE cable : it used to connect HDD, CD ROM, DVD ROM
- c. FDD cable: it used to connect FDD (braking or manufacture defecting)

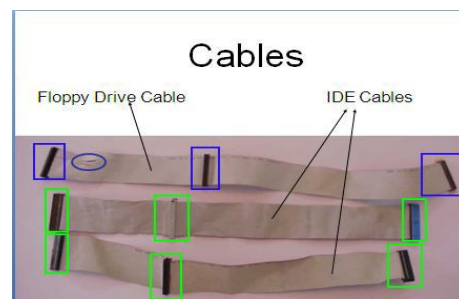

23. Hard Disk Drive:

- a. The hard disk drive is the main, and usually largest, data storage device in a computer
- b. The operating system, software titles and most other files are stored in the hard disk drive
- c. Identifications is the panel name is Hard Disk drive

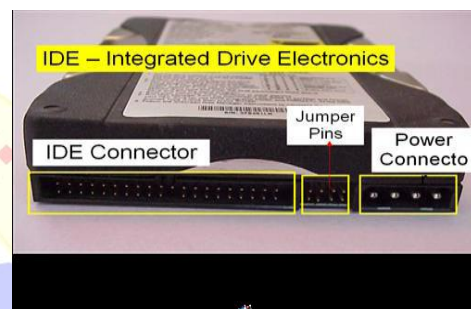

24. CD ROM Drive & CD-Writer:

- a. CD-Rom (Compact Disk Read only Memory) Drive is a device that reads the information from Compact Disks (CD).
- b. CD-Writer is used to write the data into Compact Disks.
- c. Identification is the panel name is CD Writer



25. Floppy Disk Drive:

- a. The floppy disk drive is used to read the information stored in floppy disks.
- b. Floppy disks also called as a diskette.
- c. Identification is smaller than CD writer.



26. SMPS:

- a. SMPS is used to supply the power to Mother Board HDD,CD ROM, FDD



C LAB MANUAL

- b. In SMPS holds a transformer, voltage control and fan
- c. Identification is the rectangular box shape and panel name is switching mode power supply.

27. CPU heat Sink and fan**28. Different Screws Used****29. USB Ports**

C LAB MANUAL

AIM: To assemble and disassemble the system

Why should one learn about hardware?

1. Troubleshoot you and save time.
2. Knowing about system internals and components.
3. Very easy installation for modern hardware.
4. Install extra memory.
5. Removing components.

Safety Precautions:

1. Beware of electrostatic discharge (ESO)
2. Build computer on a hard surface, away from concepts.
3. Wear shoes and the short sleeved cotton wear.
4. Use Phillips, head screw driver.
5. Keep the components away from moisture.
6. Avoid using pressure while installing.

Steps for Deassembling.

1. Disassembling means parting the different components of a computer from the system unit:
2. To perform disassembling, the tasks goes like unplugging, unscrewing and then lifting the adapters, drives & other components.
3. The first thing we have to do, is unplug every cable that's plugged in to computer. That includes the following cables: Power, USB, Fire wire, Mouse, Keyboard, Internet, Ethernet, Modem, AM/FM Antenna, Cable TV etc...
4. First off, we have to unscrew the four screws on the back of the computer.
5. Once the screws are removed, we can remove the side panels.
6. Just like the side panels, the top panel slides off
7. System fan is located at the back side of the computer, the side with all the component plug-ins.

C LAB MANUAL

8. First, we have to unplug the fan from the motherboard. The system fan should be labeled "SYS_FAN1".
9. Next, we will have to unscrew the fan from the outside. We should now be able to lift the fan out of the PC
10. The CPU fan is located right on top of the CPU heat sink, which is a large piece of metal with fins on the top.
11. The power supply supplies power to every component in a computer. The list below is everything that to disconnect: Motherboard (very large connector/plug), CD/DVD drive[s] power, Internal hard drive power, Portable hard drive slot power
12. The CD/DVD drive is one of the easiest components to remove. First, unplug the ribbon from the back of the drive. Once that is completed then push it out from the inside.
13. Just like every other component, unplug the wire first. Then unscrew them all! After that, the card reader should be removable.
14. First off, de-attach the connector at the back of the slot, and unplug the other end from the motherboard. To remove the hard drive from the side of the slot, unscrew the four screws securing it in place. You must be very careful not to drop the hard drive, as it is very delicate!
15. Expansion cards give computer new capabilities, once installed. Different examples are: Bluetooth, Wireless Internet, Ethernet, TV
16. Remove the screws on the occupied card slots. Once the screws are removed, you should be able to remove the cards by pulling them carefully upward.
17. The connectivity center is the area on the front of the computer where there is many input sections, like usb, fire wire, microphone, headphones, video, etc.
18. To remove the RAM, push down on both tabs holding the RAM in place, which are located at both ends of the RAM. Please see the pictures.
19. The power button, power LED, and hard drive LED are all within a plastic "chasis".
20. To remove the LEDs from the "chasis", push them from the front with a screw driver.
21. First thing, unscrew the single screw holding it in place.

C LAB MANUAL

22. Once the screw[s] is removed, the whole component should slide into the inside of the computer, which can then be removed.
23. The motherboard links every component in the computer together. The motherboard has seven screws holding it to the frame. Remove those seven, then lift the motherboard out of the frame.

Steps for Assembling.

1. Setting the cabinet ready.
2. Preparing to fit the components.
3. Fitting the mother board.
4. Fitting the RAM, processor and cooler.
5. Installing PCI cards.
6. Fitting the hard disk and floppy drive.
7. Installing the CD ROM drives.
8. Connecting the ribbon cables.
9. Powering the drives and mother board.
10. Connecting the cables for the case front panel.
11. Final check.

Getting the Cabinet ready:-

1. Check how to open the cabinet and determine where to fix the components.
2. Determine if the case has the appropriate risers installed.

Preparing to fit the Components:

1. Network adapter drive.
2. Floppy disk drive.
3. Ribbon cables.
4. Hard disk.
5. CD-ROM Drive.
6. RAM
7. CPU
8. Heat sink / cooler / fan.

C LAB MANUAL

9. Mother board.
10. Screws.

Fitting the Mother board.

1. Line up the patch on the motherboard (ps/1, USB, etc) with the appropriate holes in the block panel I/O shield of the case.
2. Check the points where you and to install
3. Install them and make the mother board sit on them and fix screws if required.

Mother board parts:

1. ACR slot.
2. PCI Slot.
3. AGP Slot.
4. ATX Connectors.
5. CPU Fan.
6. Chipset North Bridge.
7. CPU socket.
8. Floppy.
9. System memory.
10. Chipset south bridge.
11. Panel connector.
12. Power supply.
13. IDE connectors.

ATX Connectors:

1. PS, Mouse.
2. Key board.
3. USB.
4. Parallel (Prints)
5. Serial COM1.
6. Serial COM 2.
7. Joystick.

C LAB MANUAL

8. Sound.

Fitting the processor:

1. Raise the small lever at the side of the socket.
2. Notice that there is a pin missing at one corner, determine the direction to fit in the processor.
3. You should not force the CPU. When inserting it. All pins should slide smoothly into the socket.
4. Lock the lever back down.
5. Install the heat sink over it (Different type for each processor). Heat sink / CPU fan.

Fitting the RAM:

1. The RAM must be suitable for motherboard.
2. There are currently 3 types of RAM available.
 - a) SD RAM.
 - b) DDR SD RAM.
 - c) RD RAM.
3. The mother board's chipset determines which type of RAM may be used.

Installing the PCI Cards:

1. Most of the cards are inbuilt these days.
2. NIL, Sound Cards etc. are fitted into PCI slots.

Fitting the hard disk and Floppy disk:

1. Place the floppy and hard disks in their slots.
2. Leave some space above HDD to prevent heat building.
3. Check the jumper configuration.
4. Fix the screws.

Installing the CD-ROM Drives:

C LAB MANUAL

1. CD-ROM drive is similar to installing a hard disk.
2. 1ST check that the jumper configuration is correct.
3. Fix the screw.

Connecting the ribbon Cables:-

1. Attach the long end of the cable to the IDEU connector on the motherboard first.
2. The red stripe on the IDE cable should be facing the CD Power.

Powering the driver and motherboard:

Connecting the cables for the case front pane

1. SD, SPK or SPEAK: The loud speakers o/p. it has 4 pins.
2. RS, RE, RS or RESET: Connect the two pin Reset cable here.
3. PWR, PW, PWSW, PS or power SW: Power switch, the pc's on (switch, the plug is two pin).
4. PWLED, PWRLED or Power LED: The light emitting diode on the front panel of the case illuminates when the computer is switched on. It's a 2-pin cable.
5. HD, HDD, and LED: These two pins connect to the cable for the hard disk activity LED.

Final Check:-

1. Mother board jumper configurations are the settings for the processor operator.
2. Drive jumper settings, master/ slave correct?
3. Are the processor, RAM modules and plug in cards finally seated in there sockets?
4. Did you plug all the cables in? Do they all fit really?
5. Have you tightened all the screws in plug- in cards or fitted the clips?
6. Are the drive secure?
7. Have u connected the power cables to all driver?

C LAB MANUAL**Powering up for the first time:**

1. Ensure that no wires are touching the CPU heat sink fan.
2. Plug your monitor, mouse and keyboard.
3. Plug in power card and switch the power supply.
4. If everything is connected as it should be
 - All system, fans should start spinning.
 - U should hear a single beep and after about 5-10 sec.
 - Amber light on monitor should go green.
 - You will see computer start to boot with a memory check.
 - Now check front LED'S to see if u plugged them in correctly.
 - Check all other buttons.
 - Power afford change any wrong settings.

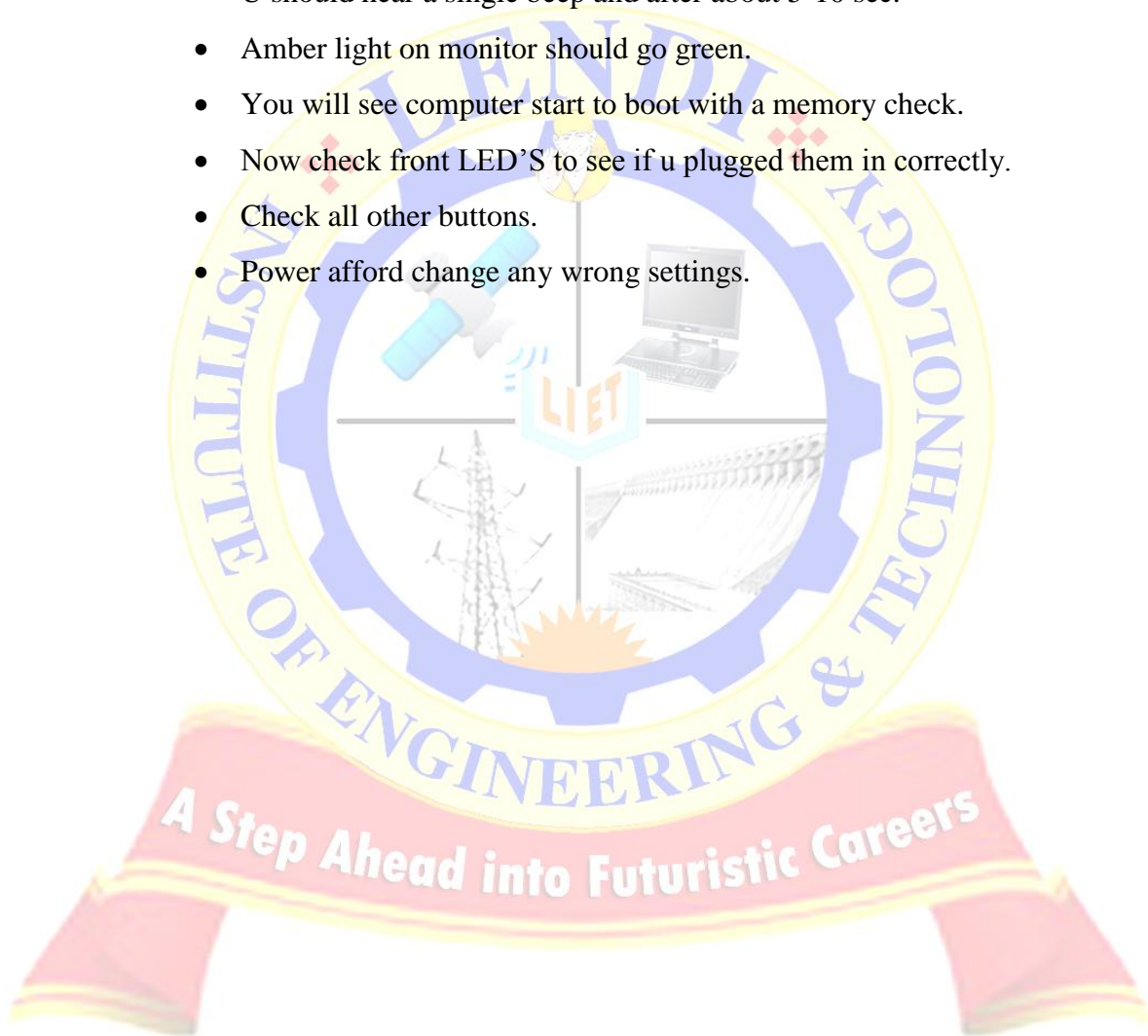

C LAB MANUAL**EXERCISE 15(B)**

AIM: Operating System Installation-Install Operating Systems like Windows, Linux along with necessary Device Drivers.

PROCEDURE:

1. Keep on press the delete button and go to advanced BIOS feature. [BIOS- Basic Input Output System]
2. And go to boot sequence. Select first boot drivers. CD ROM and press F10 to save the bios feature. Yes and then enter. Press any key to boot from CD. Press enter to setup windows XP.

F8 = To agree the license.

3. Press ESC to don't repair the windows XP setup.
4. Press 'p' to delete the previous partitions. Then press enter.
5. Press 'L' to delete the partition.
6. Press 'C' to create the partition in the un partition space.
7. Press enter to setup windows XP on the selected items.

BASIC FILE SYSTEMS:

FAT: File Allocation Table.

NTFS: New Technology File System.

Format the create using NTFS partition

BASIC STEPS IN INSTALLATION:-

- Collecting information.
 - Dynamic update.
 - Preparing installation
 - Installing windows.
 - Tracking installation. Then
1. Select the language as English (united status), then ok.

C LAB MANUAL

2. Enter your name and organization.
3. Enter the product key.
4. Enter the computer name and give password (if necessary) then ok.
5. Then select the date and time.
6. Then select the typical settings.
7. Then click on next.
8. Setup completion. From this point on setup will continue to completion without any further need for interaction. Setup will now copy files, complete installation, install your start menu items, register system component, save settings, remove any temporary files need to be setup. After system will again reboot. And while rebooting the system it will ask “Press any key to boot from CD” again. At this time also do not press any key.
9. First Reboot. You will be greeted by the XP splash screen on first boot.
10. Change Display settings. Users with CRT monitors or LCD monitors will see a display settings dialogue appear. It will ask you like to change your display settings automatically. Then Click OK and it will shows your screen with modified display settings and ask keep this settings for your computer. Press OK to continue.
11. Setup Network and Set up users. Now you can enter the at least one user name, that could be anything. And click NEXT to continue. After creating users it will shows FINISH button. Click that FINISH completing your XP installation.

AIM: To install Linux in Operating system

PROCEDURE:

1. Language Selection

- Using your mouse select the language you would prefer to use for the installation
- Click next to continue.

2. Key Board Configuration:

- Using your mouse select the correct layout type for the keyboard you would prefer to use for the installation and as the system default.

C LAB MANUAL

- Once you have made the selection click next to continue.

3. Mouse Configuration:

- If you have a PS/2 ,USB or Bus mouse you do not need to pick a port and device. If you have a serial mouse, you should choose the correct port and device that your serial mouse is on.
- The **Emulate 3 buttons** checkbox allows you to use a two-button mouse as if it had three buttons. If you select this check box you can emulate a third “middle” button by pressing both mouse buttons simultaneously.

4. Installation Type:

- Choose the type of installation you would like to perform.
- Your options are **Personal desktop, Workstation, Server, Custom** and **upgrade**

5. Disk partition Setup:

- You can chose automatic partitioning or manual partitioning using **Disk Druid** of **fdisk**.
- Automatic partitioning allows you to perform an installation without having to partition your drives yourself.
- Automatic partitioning allows you to have some control concerning what data is removed from your system.
- Your options are:
 - ✓ Remove all Linux partitions on this system.
 - ✓ Remove all partitions on this system
 - ✓ Keep all partitions and use existing free space.
- To partition manually choose either Disk druid or fdisk partitioning tool.
- Lick next once you have made your selections.

5. Partitioning your system:

- If you chose automatic partitioning and did not select **Review** skip ahead
- If you choose automatic partitioning and selected **review** you can either accept the current partition settings (click next) or modify the setup using **Disk Druid**, the manual partition tool.

C LAB MANUAL

- If you choose manual partition with fdisk skip ahead.
- At this point you must tell the installation program where to install Linux. This is done by defining mount points for one or more disk partitions in which Linux will be installed.

6. Adding Partitions:

- To add a new partition select **new** button, a dialogue box appears.
- Select the options and click **ok**

7. Boot Loader Configuration:

- Boot loader is the first software program that runs when a computer starts.
- The installation program provides two boot loaders **GRUB (GR and Unified Boot Loader)** which is the default and **LILO**
- If you do not want GRUB as your boot loader click **Change Boot Loader.**
- You can then choose to install LILO or choose not to install boot loader at all by clicking **Do not install boot loader** on the **change boot loader** button.
- Network devices are automatically detected and displayed in **Network Devices** list,
- Select a network device and click **Edit**
- Here you can configure IP address and net mask of the device.

8. Firewall configuration:

- Offers firewall protection for enhanced protection.
- A properly configured firewall can greatly increase the security of the system.

9. Time zone configuration:

You can set your time zone by selecting your computers physical location or by specifying your time zones offset from Universal Time.

10. Account Configuration:

- Allows to set Root password or user accounts
- Root count is similar to the administrator password that you set up in Win NT.
- Click **add** button to add a new non-root user.

C LAB MANUAL

- Enter the details and click **OK**.

11. Packing group selection:

You can select package groups which groups components together or individual packages or a combination of the two.

Device drivers:

A device driver is a computer program that operates or controls a particular type of device that is attached to a computer. A driver provides a software interface to hardware devices, enabling operating systems and other computer programs to access hardware functions without needing to know precise details of the hardware being used.

Sample screens for installation of device drivers such as sound, internet, chipset and video

Step 1: insert drivers CD in CD ROM then automatically it shows this screen



Step 2: then double click on open folder to view files

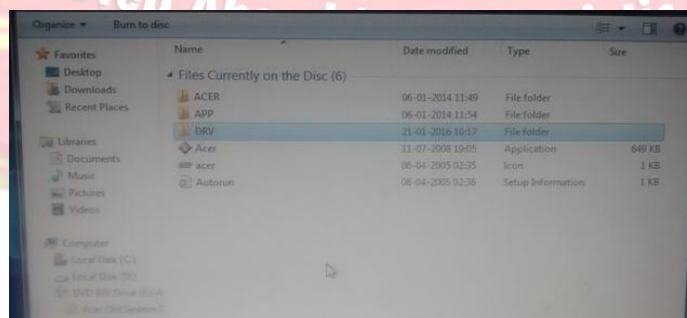

C LAB MANUAL

Step 3: then it shows different system drivers such as audio, vedio etc.

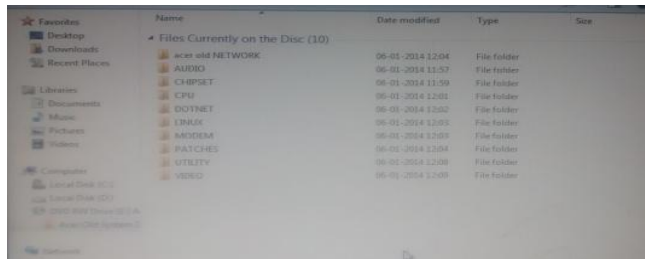

Step 4: now select audio drivers

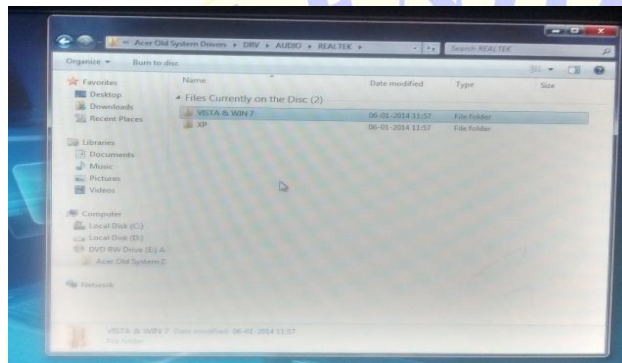

Step 5: then it shows 32 bit and 64 bit.

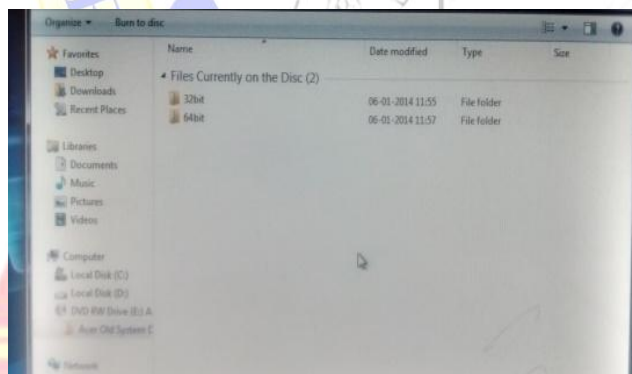

Step 6: then open 32 bit in that set up file is there

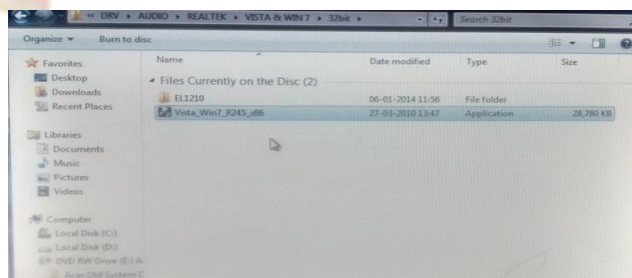

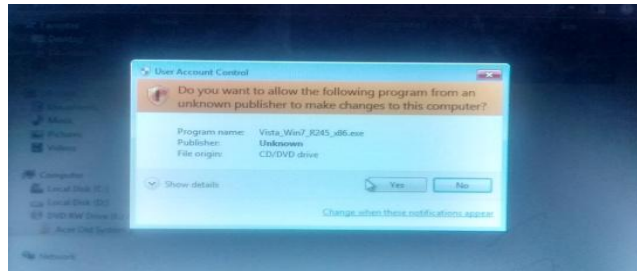
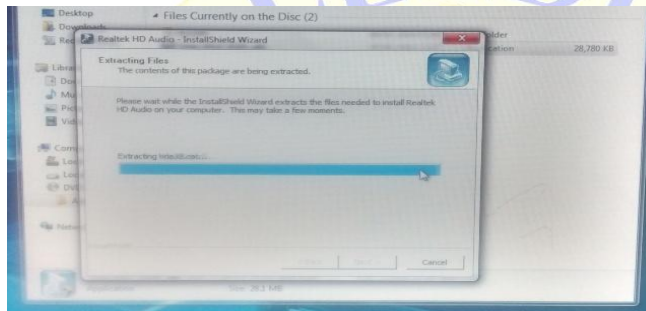
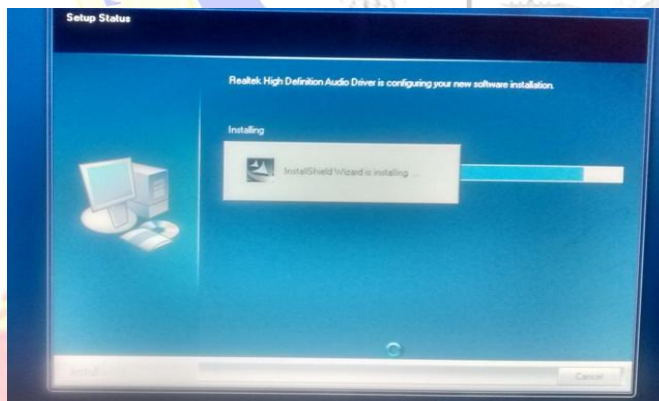
C LAB MANUAL**Step 7: install setup file****Step 8: still installing****Step 9: installing.....**

C LAB MANUAL

Step 10: setup completed.....

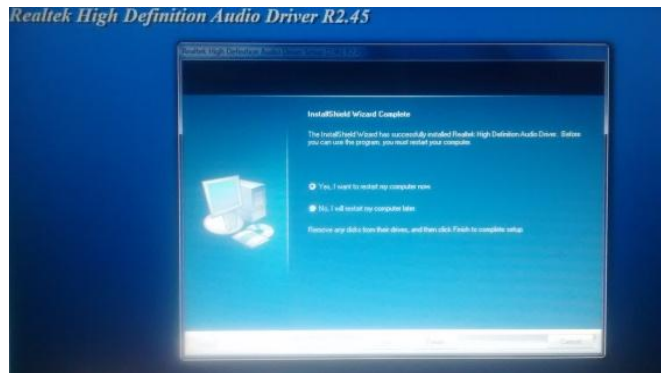
**VIVA-VOCE QUESTIONS:**

1. What is CPU?
2. What is assembling?
3. What are the units of memory?
4. Give an example of Operating System?
5. Give an example of processor?

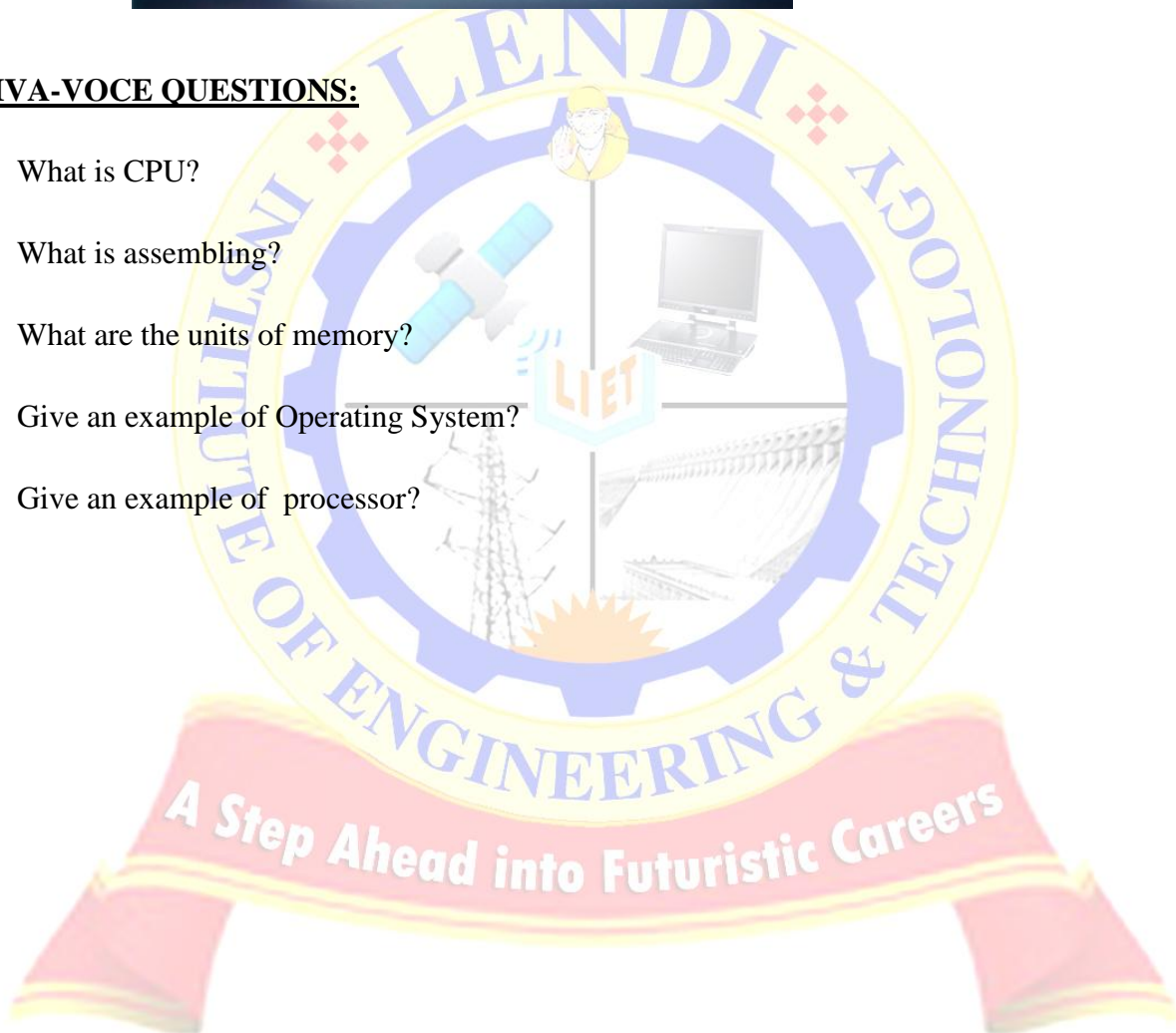

C LAB MANUAL**EXERCISE 16(A)**

AIM: a) MS-Office / Open Office

i) **Word** - Formatting, Page Borders, Reviewing, Equations, symbols.

ii) **Spread Sheet** -organize data, usage of formula, graphs, charts.

iii) **PowerPoint** - features of power point, guidelines for preparing an effective presentation.

b) Network Configuration & Software Installation-Configuring TCP/IP, Proxy, and firewall settings. Installing application software, system software & tools.\

Word - Formatting, Page Borders, Reviewing, Equations, symbols.

Microsoft Office Word 2007 allows you to create and edit personal and business documents, such as letters, reports, invoices, emails and books. By default, documents saved in Word 2007 are saved with the **.docx** extension. Microsoft Word can be used for the following purposes:

- To create business documents having various graphics including pictures, charts, and diagrams.
- To store and reuse ready-made content and formatted elements such as cover pages and sidebars.
- To create letters and letterheads for personal and business purpose.
- To design different documents such as resumes or invitation cards etc.
- To create a range of correspondence from a simple office memo to legal copies and reference documents.

Accessing (Word 2007 Basics)

The Microsoft Office Button is located in the upper left-hand corner of the program window. It replaced the old File menu found in previous versions of Microsoft Word. The Office Button menu contains basic file management commands, including New, Open, Save, Print, and Close.

To Create a New Document - Click the Office Button, select New, and click Create, or press <CTRL> + <N>.

C LAB MANUAL

To Open a Document - Click the Office Button and select Open, or press <CTRL> + <O>.

To Save a Document - Click the Save button on the Quick Access Toolbar, or press <CTRL> + <S>.

To Save a Document As - Click the Office Button, select Save As, and enter a new name for the document.

To Preview a Document - Click the Office Button, point to the Print list arrow, and select PrintPreview.

To Print a Document - Click the Office Button and select Print, or press <CTRL> + <P>.

To Undo - Click the Undo button on the Quick Access Toolbar or press <CTRL> + <Z>.

To Close a Document - Click the Close button or press <CTRL> + <W>.

To Get Help = Press <F1> to open the Help window. Type your question and press <ENTER>.

To Exit Word - Click the Office Button and click Exit Word.

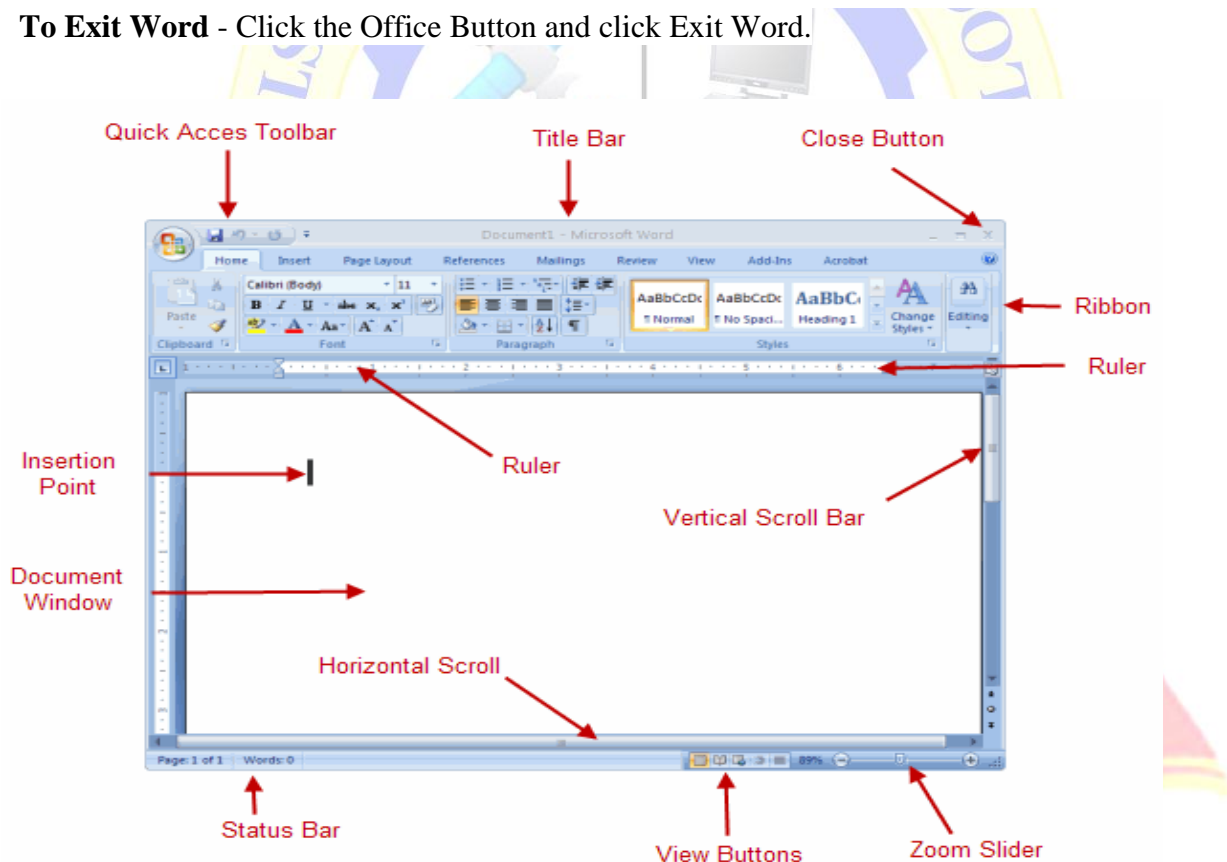

C LAB MANUAL

Page Setup and Margin Formatting

The screenshot below displays the menu path to change the margins in a paper. All margins are set at 1 inch.

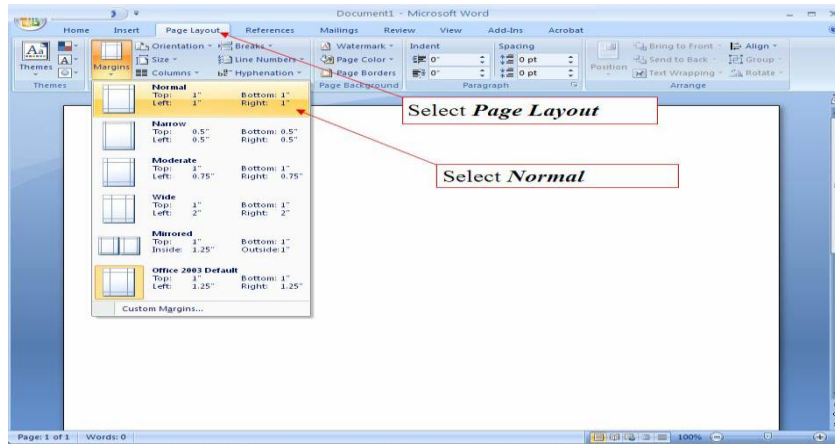

1. From the menu tab at the top of Word, select *Page Layout*.
2. In the *Page Layout* menu, the margins button will allow you to change the margins to the correct format.
3. Select *Normal* to set all margins to one inch.

Formatting Font

The screenshot below displays the menu path to change the font. Use a traditional font such as Times New Roman or Courier in 12-point size.

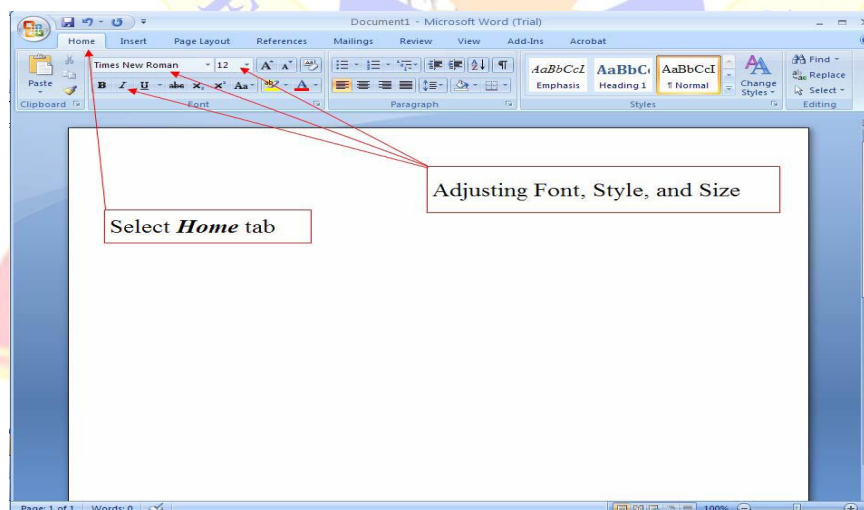

C LAB MANUAL

1. Select the *Home* tab.
2. From the *Font* menu, you may adjust the font, style, and size to the correct format.

Formatting Spacing

The standard spacing format for a paper is double-spacing. Double-space the entire document, including the reference page. The screenshot below displays the menu path to change the spacing format to double.

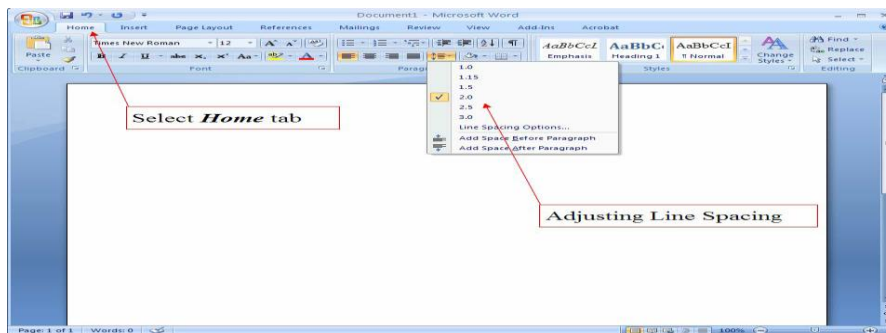

1. Select the *Home* tab.
2. From the *Paragraph* menu, you may adjust the line spacing from the *Line Spacing* dropdown menu.

Centering Text

The screenshot below is an example of text that is centered and that is not centered. In order to center text highlight the text that requires centering and select the icon in the formatting toolbar as shown.

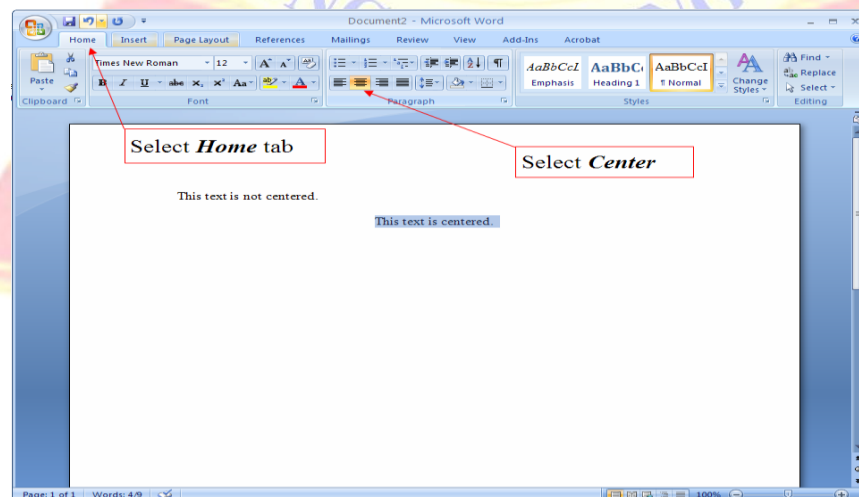

C LAB MANUAL

Header and Footer:

1. To create a header, enter text or graphics in the header area or click button on the header and footer tool bar.
2. To create footer, click switch between header and footer.
3. Then click exit or
4. Click the Insert tab on the Ribbon and click the Page Break button on the Page Setup group.

Create a Bulleted or Numbered List

Select the paragraphs you want to bullet or number and click the Bullets or Numbering button in the Paragraph group on the Home tab.

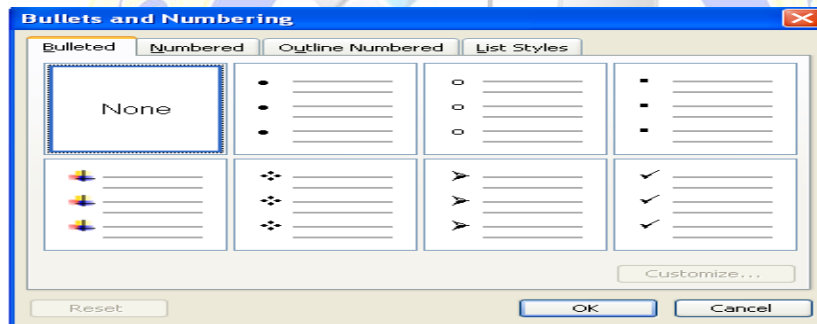

Changing text direction:

We can change the text orientation in drawing objects, such as text boxes, shapes, and callouts, or in table cells so that the text is displayed vertically or horizontally.

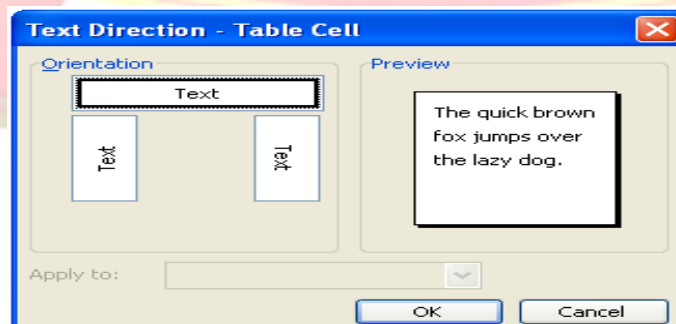

C LAB MANUAL

Changing Text direction:

1. Click the drawing object or table cell that contains the text you want to change.
2. On the Format menu, click Text Direction.
3. Click the orientation you want.

Table:



1. Click where you want to create a table.
2. On the Table menu, point to Insert, and then click Table.
3. Under Table size, select the number of columns and rows.
4. Under AutoFit behavior, choose options to adjust table size.
5. To use a built-in table format, click AutoFormat.

Select the options you want

Cell Alignment:

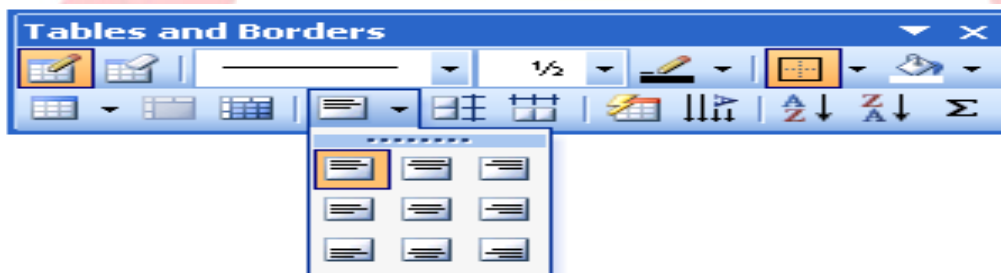

C LAB MANUAL

1. Click the cell that contains text you want to align.
2. On the Tables and Borders toolbar, select the option for the horizontal and vertical alignment you want— for example, Align Bottom Center or Align Top Right.

Foot Note:

1. In print layout view, click where you want to insert the note reference mark.
2. On the Insert menu, point to Reference, and then click Footnote.
3. Click Footnotes or End notes.

By default, Word places footnotes at the end of each page and endnotes at the end of the document. You can change the placement of footnotes and endnotes by making a selection in the Footnotes or Endnotes box.

4. In the Number format box, click the format you want.
5. Click Insert.

Word inserts the note number and places the insertion point next to the note number.

6. Type the note text.
7. Scroll to your place in the document and continue typing.

As you insert additional footnotes or endnotes in the document, Word automatically applies the correct number format.

Page Borders

1. Open Microsoft Word.
2. Click on the **Page Layout** tab.
3. On the Page Layout tab, in the Page Background group, click Page Borders.
4. Click one of the border options under Settings.
5. Select the style, color, and width of the border.
6. Once you've selected all the border options you want to use in your document, click the **Ok** button to apply the border.

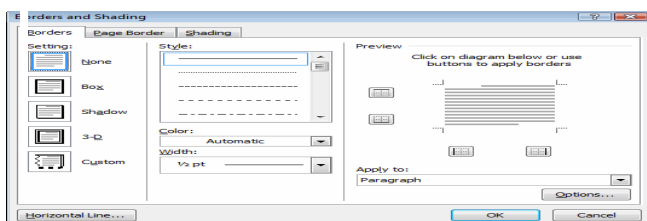

C LAB MANUAL

Reviewing

Step 1: Open review in tool bar

Step 2: checking for spelling correct or not

Step 3: if it is correct then it shows green color otherwise it shows red in color

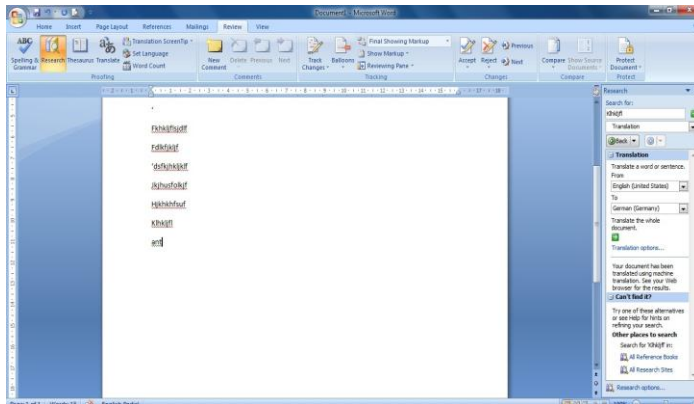

Equations

1. Click on insert option
2. Click on equation symbol (right side corner)
3. Then it opens equation tools
4. Select equation
5. And close

Open tool bar and click on equation then it shows different equations

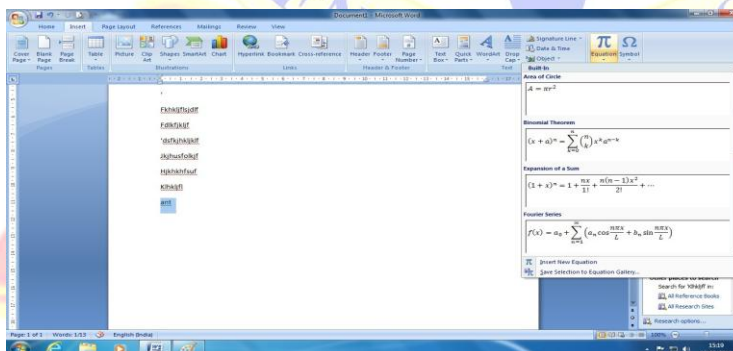

If we want any type of equation just click on that

C LAB MANUAL

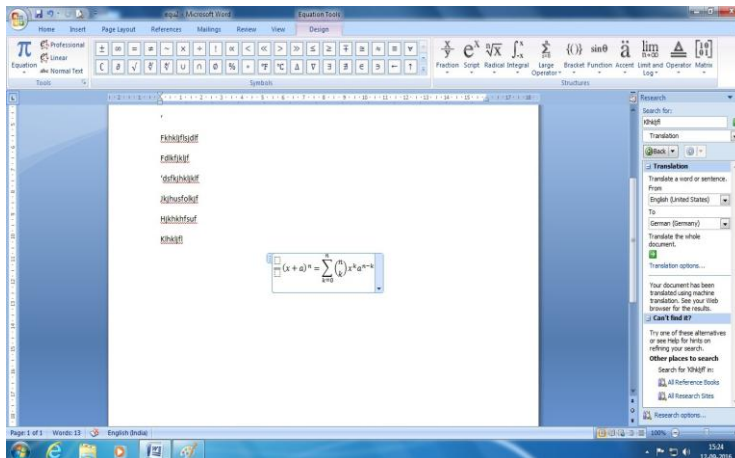

Symbols

1. Click where you want to insert the symbol.
2. On the Insert menu, click Symbol, and then click the Symbols tab.
3. In the Font box, click the font that you want.
4. Double-click the symbol that you want to insert.
5. Click Close

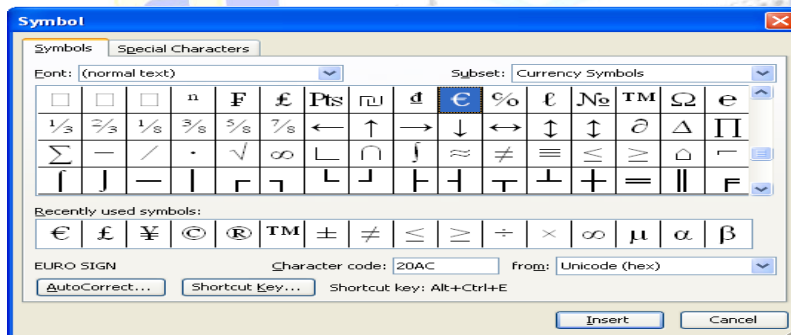

C LAB MANUAL

EXERCISE 16(A-II)

AIM: Spread Sheet- organize data, usage of formula, graphs, charts

Microsoft Excel is a spreadsheet program included in the **Microsoft Office** suite of applications. Spreadsheets present tables of values arranged in rows and columns that can be manipulated mathematically using both basic and complex arithmetic operations and functions.

Starting Excel

- You start Excel from the Start menu in Windows. Click the Start button, click All Programs, click Microsoft Office, and then click Microsoft Excel 2007.
- The Excel program window has the same basic parts as all Office programs: the title bar, the Quick Access Toolbar, the Ribbon, Backstage view, and the status bar.

Exploring the Parts of the Workbook

- Each workbook contains three worksheets by default. The worksheet displayed in the work area is the active worksheet.
- Columns appear vertically and are identified by letters. Rows appear horizontally and are identified by numbers.
- A cell is the intersection of a row and a column. Each cell is identified by a unique cell reference.

Excel program window

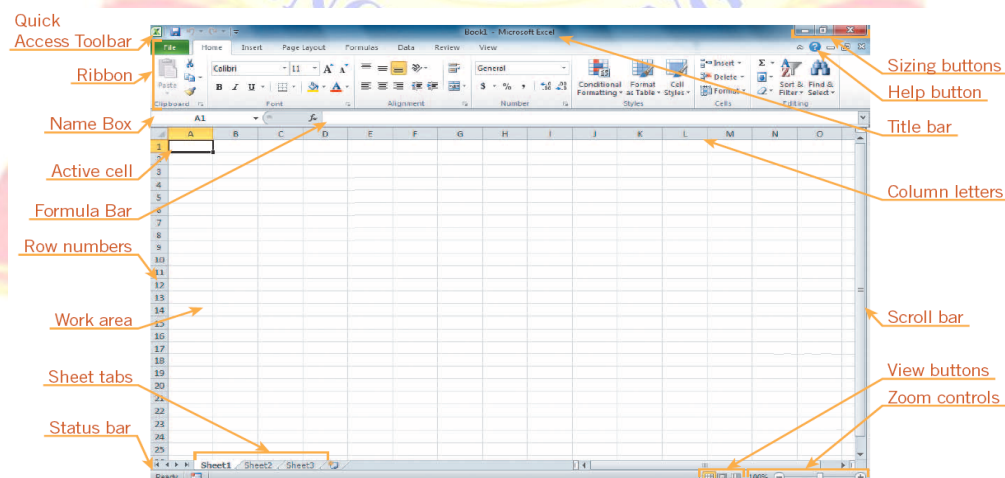

C LAB MANUAL

Organize data

In MS Excel, there are **1048576*16384** cells. MS Excel cell can have **Text, Numeric value or formulas**. An MS Excel cell can have maximum of 32000 characters.

Inserting Data for inserting data in MS Excel, just activate the cell type text or number and press enter or Navigation keys.

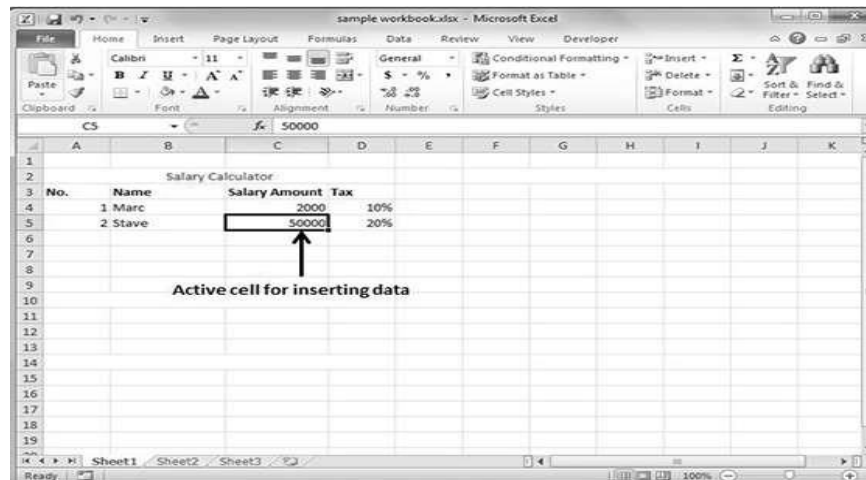

Modifying Cell Content

For modifying the cell content just activate the cell, enter a new value and then press enter or navigation key to see the changes. See the screen-shot below to understand it.

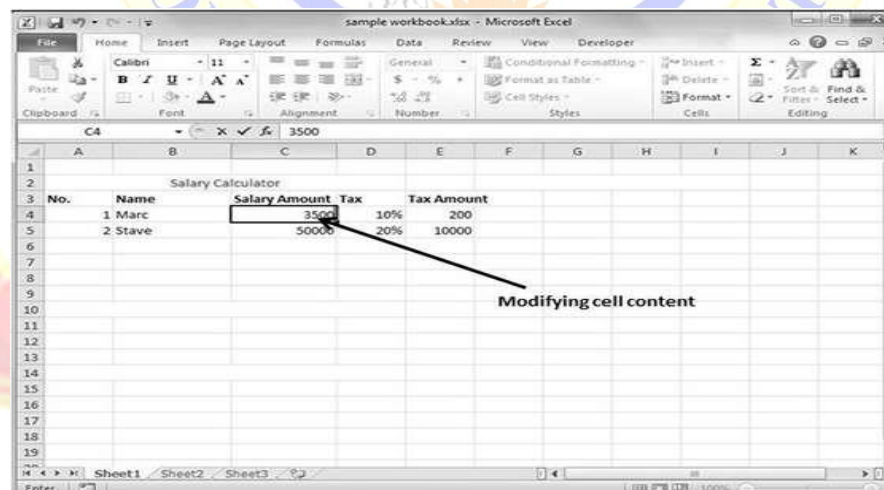

C LAB MANUAL

MS Excel provides various ways of deleting data in the sheet. Let us see those ways.

Delete with Mouse

Select the data you want to delete. **Right Click** on the sheet. Select the **delete option**, to delete the data.

Delete with Delete Key

Select the data you want to delete. Press on the **Delete Button** from the keyboard to deletes the data.

Selective Delete for Rows

Select the rows, which you want to delete with **Mouse click + Control Key**. Then right click to show the various options. Select the **Delete option** to delete the selected rows.

Copy Paste

- To copy and paste, just select the cells you want to copy. Choose **copy option** after right click or press **Control + C**.
- Select the cell where you need to paste this copied content. Right click and select **paste option** or press **Control + V**.

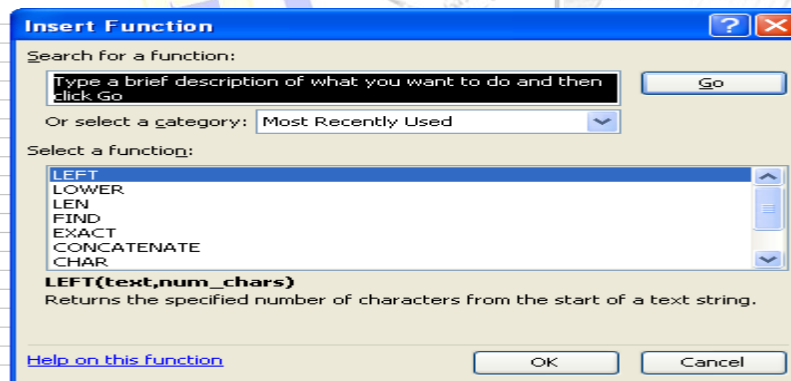

Formulae in Excel:

First click on start button at the bottom of the screen on status bar. Click on programs and then on Microsoft excel. Then open a new document. Give the main heading and subheading by changing the size so that they look in block letters. Enter the data. To calculate go to Insert menu in the menu bar and then click on function and then ok. Then select the data to which you want to calculate mean. Then you get the required answer. In same way, sample means standard

C LAB MANUAL

deviation lower count limit and upper count limit. Go to insert menu and click on function and select the required operation to be done and select the data and calculate. Formulas for all the above are given below.

$$\text{Mean} = (s1 + s2 + s3 + s4 + s5)/5;$$

$$\text{Sample mean} = \text{avg (mean)}$$

$$\text{Standard deviation} = (\text{mean, sample, mean})$$

$$\text{Sample standard déviation} = \text{avg (Standard déviation)}$$

$$\text{Lower count limit} = \text{sample mean} - \text{sample standard deviation.}$$

$$\text{Upper count limit} = \text{Sample mean} + \text{Sample Standard deviation}$$

1. Select formulas in tool bar
2. In insert function all the values must be inserted and apply functions like addition, subtraction, average etc., then enters one by one numbers for result.

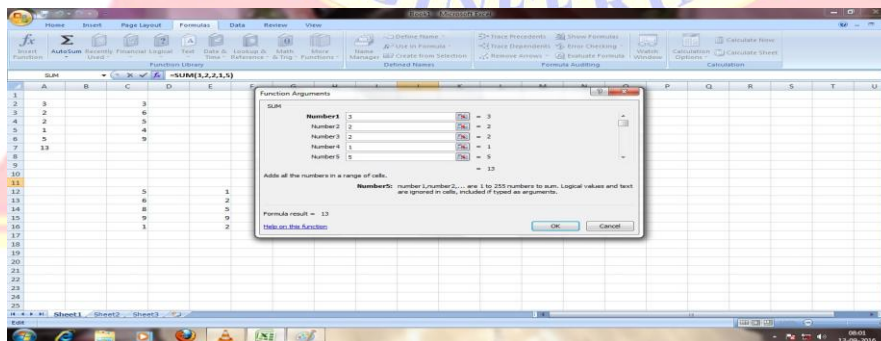
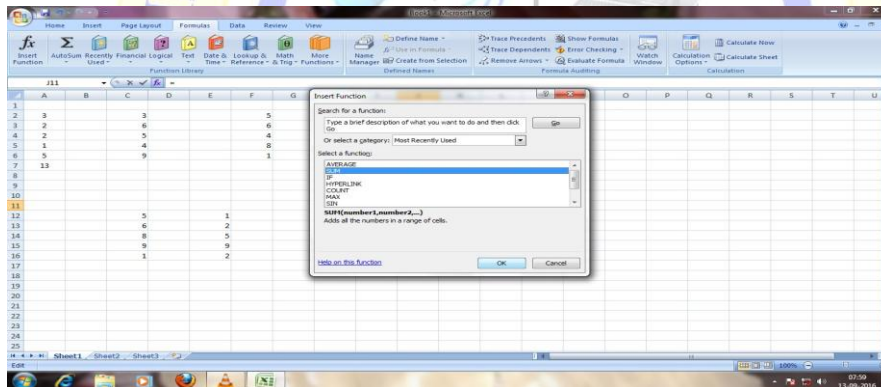

3. Here first select which cells you want. Then click on auto sum

C LAB MANUAL

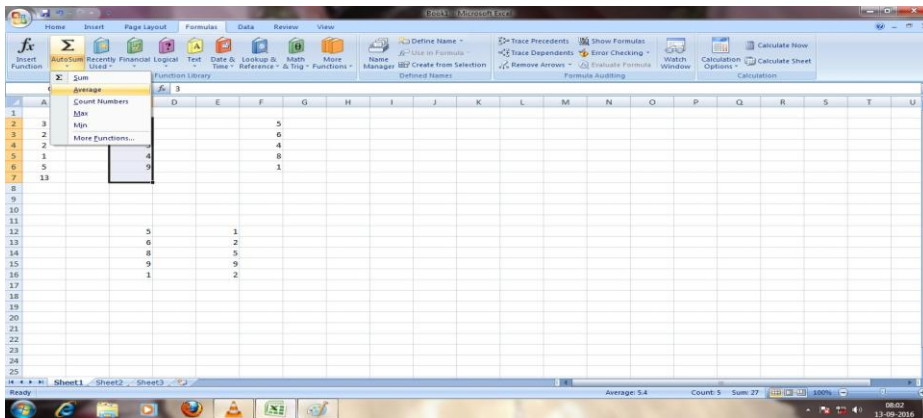

- If you want to see what formula is applied, so click on show formulas

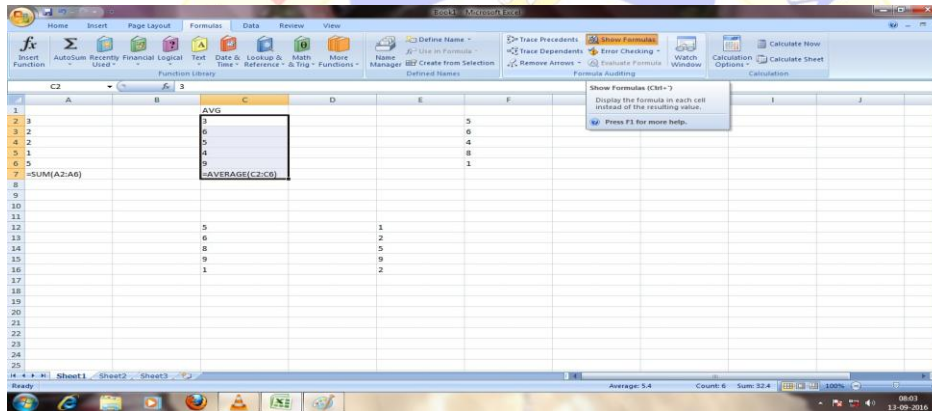

Graphs and charts

- Open excel or spread sheet
- Enter the X and Y axis points in cells and select them

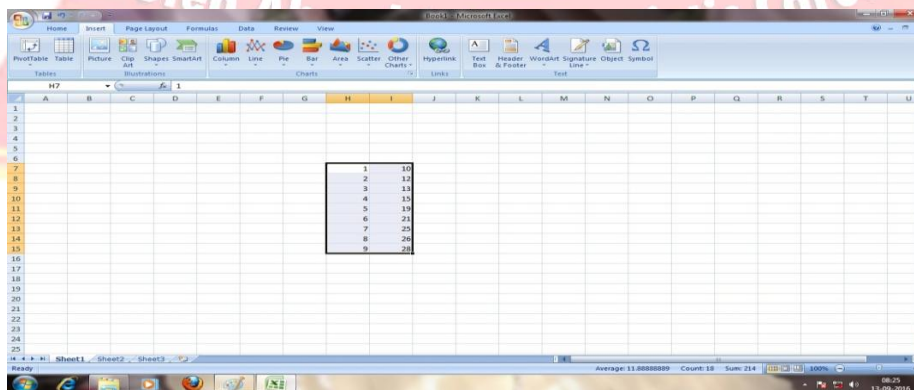

C LAB MANUAL

3. Go to tool bar
4. Click on insert option
5. Now it shown different types of graph and charts such as column, line, pie, bar, area, scatter.
6. In that select any one
7. Now I select XY scatter in insert chart which comes under other charts
8. Click on any one scatter then click on OK. Now it shows the following figure

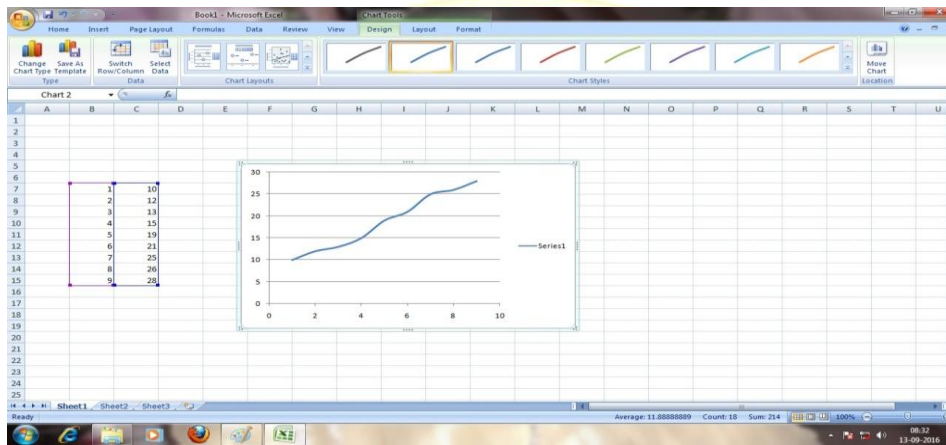

MS POWERPOINT

Power Point creates multimedia presentations to display information in a graphical format.

Features of PowerPoint

1) Adding Smart Art

Don't confuse SmartArt with the similarly named WordArt. Where WordArt just allows you to display text using a wide variety of different formats and effects, SmartArt is a comprehensive and flexible business diagram tool that greatly improves upon the 'Diagram Gallery' feature found in previous versions of Office. Click the insert Smart Chart Graphic to choose from a selection of options. SmartArt can be used to create professional diagrams that include pictures and text or combinations of the two. An obvious use of Smart Art would be to create an organization chart but it can be used for many different kinds of diagrams and even to provide some variety to slides using text bullet points.

C LAB MANUAL

2) Inserting Shapes

If you need to include some sort of diagram in your presentation, then the quickest and easiest way is probably to use SmartArt. However, it is important to be able to include shapes independently of SmartArt and worth being familiar with the various Drawing Tool format options. Not only will they be useful if you do need to manually draw a diagram (and SmartArt doesn't suit all diagrams), but they can also be applied to objects on a slide that you might not immediately think of as shapes. For example the box that contains your slide title or your content. This can be anything from text to a video, or even the individual shapes in a SmartArt diagram. As you can see, the gallery of available shapes is very extensive. Once you have selected your chosen shape, you can just click in your slide to insert a default version of the shape or, to set a particular size and position, click and drag with the mouse to create the shape and size you want.

3) Inserting an Image

Here are two content type icons which appear in new content Placeholders for inserting pictures. You can Insert Picture from File or Insert Clip Art. Alternatively, the Illustrations group of the Insert ribbon tab includes the same two tools. In addition, PowerPoint 2010 has a new 'Screenshot' option that allows you to capture an entire window or part of a window for inclusion on a slide. You can also copy any image and just paste it directly to a slide. Insert Picture from File allows you to browse to an image file saved somewhere on your system whereas Clip Art is held in an indexed gallery of different media types. Clip Art is not limited to pictures: 'The Results should be:' box lets you choose between: 'All media file types' and one or more of the following different types:

- Illustrations
- Photographs
- Video
- Audio

C LAB MANUAL

Once you have found the image you want to use, click on it to insert it into the current slide. You can now re-size and move the image accordingly with further editing options available when you right click the desired image

4) Slide Transitions

Properly used, slide transitions can be make your presentations clearer and more interesting and, where appropriate, more fun. Badly used, the effect of slide transitions can be closer to irritating or even nauseating. Simple animation effects are often used to add interest to bullet point text. Much more extreme animation effects are available but, in most cases, should be used sparingly if at all. Two main kinds of animation are available in a PowerPoint presentation: the transition from one slide to the next and the animation of images/text on a specific slide. In PowerPoint 2010 & 2013 there is also a separate Transitions ribbon tab that includes a gallery of different transition effects. These can be applied to selected slides or all slides. If you want to apply different transition effects to different groups of slides, then you might want to choose 'Slide Sorter' view from the Presentation Views group of the View ribbon.

5) Adding Animations

Whereas the transition effects are limited to a single event per slide, animations can be applied to every object on a slide – including titles and other text boxes. Many objects can even have animation applied to different components, for example each shape in a SmartArt graphic, each paragraph in a text box and each column in a chart. Animations can be applied to three separate 'events' for each object:

Entrance – how the object arrives on the slide

Emphasis – an effect to focus attention on an object while it is visible

Exit – how the object disappears from the slide

To apply an animation effect, choose the object or objects to be animated, then choose Animation Styles or Add Animation from the Animations toolbar. Where an animation is applied to an object with different components (for instance a SmartArt graphic made up of several boxes), the Effect Options tool becomes available to control how each component will be

C LAB MANUAL

animated. So for example, your animation can be used to introduce elements of an organisation chart to your slide one by one.

Guidelines for preparing an effective presentation:

SLIDE LAYOUT:

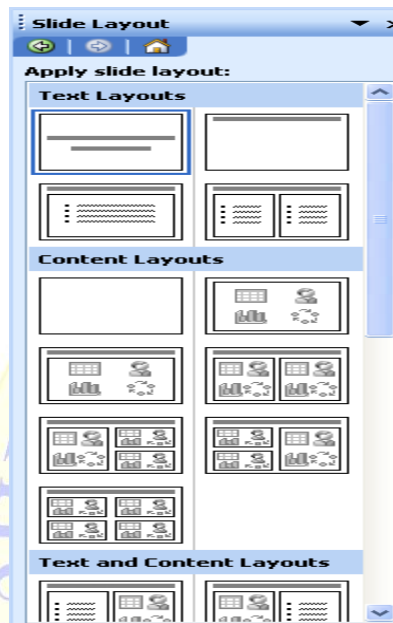

1. On the format menu, click slide layout.
2. On the slides tab in normal view, select the slides; you want to apply a layout too.
3. In the slide layout task pane, point to layout you and then click it.
4. A new slide can also be inserted within the task pane. Point the layout you want the slide to have, click the arrow and then click the insert new slide.

INSERT TEXT:

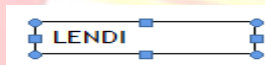

1. Text can be added to layout.
2. Align text in the top, middle or bottom of a cell.
3. Align text on the right or left, or in the center of a cell.

C LAB MANUAL

4. Change cell margins.
5. Insert a tab in a table.
6. To make the symbol command available, in normal view, place the insertion point on the outbox tab or in a text place holders on the slide.
7. On the insert menu, click symbol.
8. To change fonts, click a name in the font box.

FORMATTING TEXT:

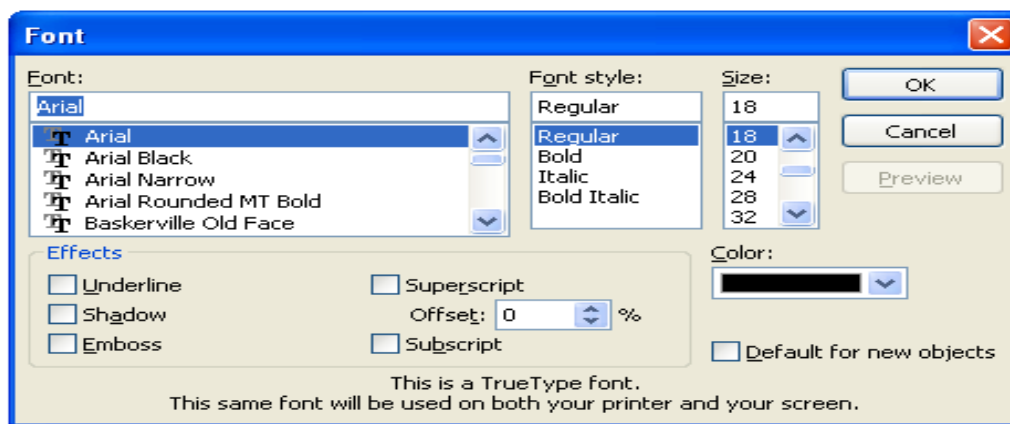

1. Select the text you want to format as superscript or subscript.
2. On the format menu, click font.
3. To show or hide text formatting, on the standard toolbar, click show formatting.

BULLETS AND NUMBERINGS:

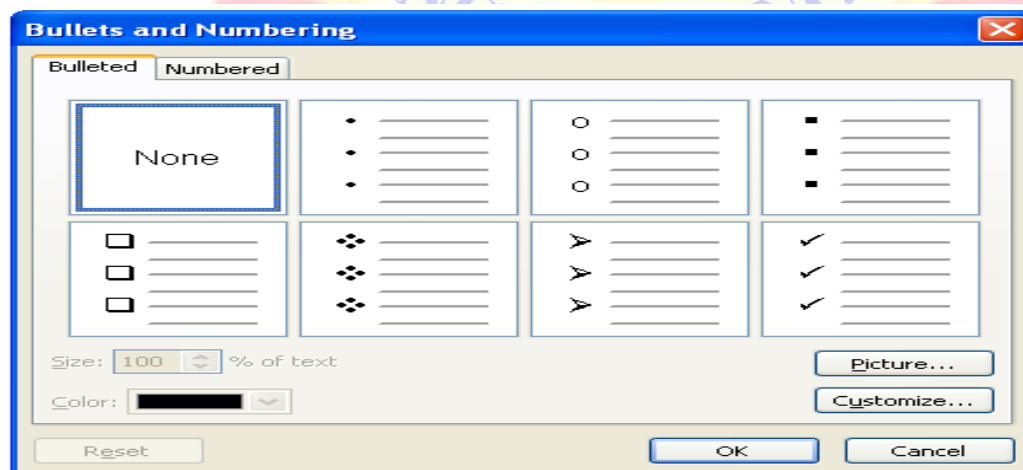

C LAB MANUAL

1. Select the lines of text that you want to add bullets or numbering to.
2. Click bullets or numbering.

AUTOSHAPES:



1. Select the auto shape that has the text you want to position.
2. Double-click the selection rectangle of the auto shape or text box and then click the text box tab in the format dialog box.
3. In the text anchor point box, click the position you want the text to start in.

LINES AND ARROWS:



1. In Microsoft power point, double click the chart.
2. Double click the chart item you want to change.
3. On the patterns tab, do one or both of the following.
4. To change the colors, patterns or lines, select the options you want.
5. To specify a fill effect, click fill effect and then select the options you want on the gradient, text patterns or picture tabs.
6. To return to the slide, click outside the about.

HYPERLINK:

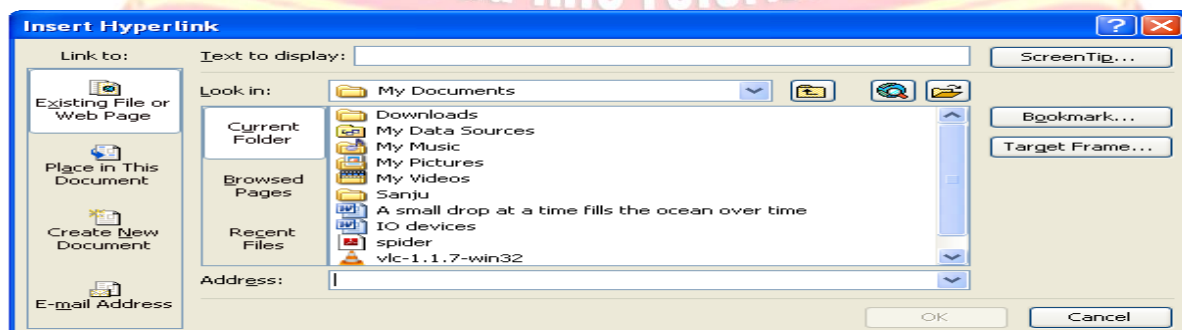

C LAB MANUAL

1. Select the text or object that you want to represent the hyperlink.
2. Click insert hyperlink.
3. Under link to, click place in this document.

INSERT IMAGES:

1. Click where you want to insert the picture.
2. On the drawing tool bar, click insert picture.

Locate the folder that contains the picture that you want to insert, and then click the picture file.



CLIP ART:

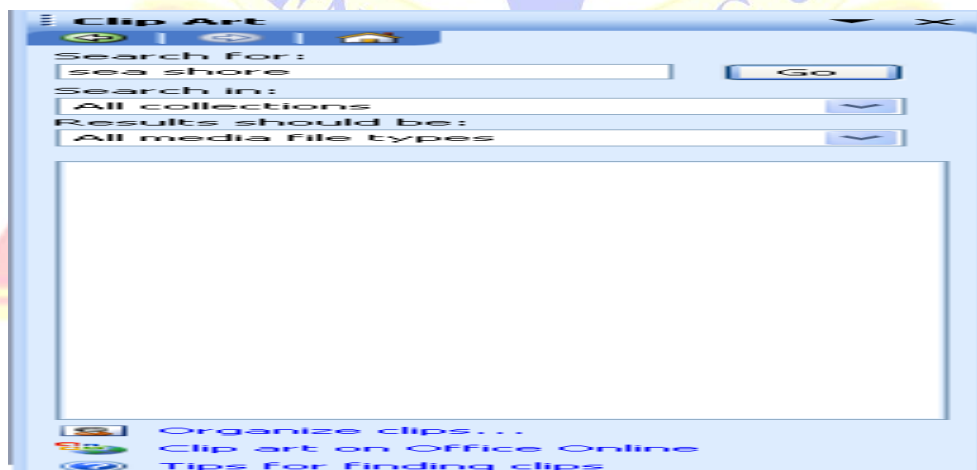

C LAB MANUAL

1. On the insert menu, point to structure and then click clipart.
2. in the clipart task pane, in the search for box, type a word or phrase that describes the clip, you want to type in all or some of the file menus of the clip.
3. in the results box, click the clip to insert it.

PROCEDURE:

First click on start button at the button of the screen on status bar. Click on programs and then Microsoft PowerPoint. Go to file and new. Then you find different pattern of slides on right side of your screen. Then select which is completely empty. Then enter the contents in the first slide as per given information, name in the second slide, Address in the third slide, Hobbies in the fourth slide and friends in the fifth slide. Except first slide, all the second, third, fourth, fifth slides should be inserted. When you select pattern of slide from a new slide, on slide which you selected you will find an arrow towards its right side, click that arrow and then again click insert slide. Then save it. Then adjust the layout. Then format the text then give bullets or numbering to the text if required. Go to auto shapes. Select more auto shapes and insert wherever required. Then again go to insert option and select new slides. And select chart and a chart with datasheet appear. Give the name, roll no, marks in three subjects and calculate the total. Then save the file.

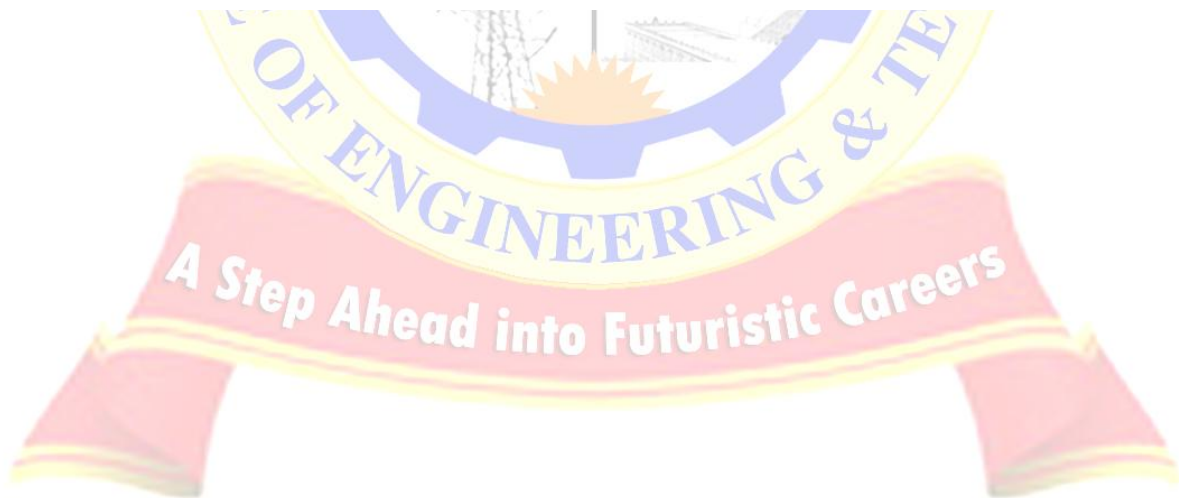

C LAB MANUAL**EXERCISE 16(B)**

AIM: Network Configuration & Software Installation-Configuring TCP/IP, Proxy, and firewall settings. Installing application software, system software & tools.

Configuring TCP/IP networking

A local area connection is created automatically if a computer has a network adapter and is connected to a network. If a computer has multiple network adapters and is connected to a network, you'll have one local area connection for each adapter. If no network connection is available, you should connect the computer to the network or create a different type of connection.

Computers use IP addresses to communicate over TCP/IP

IP addresses that are assigned manually are called static IP addresses. Static IP addresses are fixed and don't change unless you change them.

- Dynamically A DHCP server (if one is installed on the network) assigns dynamic IP addresses at startup, and the addresses might change over time. Dynamic IP addressing is the default configuration.

Configuring static IP addresses

When you assign a static IP address, you need to tell the computer the IP address you want to use, the subnet mask for this IP address, and, if necessary, the default gateway to use for internetwork communications. An IP address is a numeric identifier for a computer. IP addressing schemes vary according to how your network is configured, but they're normally assigned based on a particular network segment.

IPv6 addresses and IPv4 addresses are very different. With IPv6, the first 64 bits represent the network id and the remaining 64 bits represent the network interface. With IPv4, a variable number of the initial bits represent the network id and the rest of the bits represent the host id. For example, if you're working with IPv4 and a computer on the network segment 192.168.10.0 with a subnet mask of 255.255.255.0, the first 24 bits represent the network id and

C LAB MANUAL

the address range you have available for computer hosts is from 192.168.10.1 to 192.168.10.254. In this range, the address 192.168.10.255 is reserved for network broadcasts.

Configuring a static IPv4 or IPv6 address

One local area network (LAN) connection is available for each network adapter installed. These connections are created automatically. To configure static IP addresses for a particular connection, follow these steps:

1. Click Start and then click Network. In Network Explorer, click Network and Sharing Center on the toolbar.
2. In Network and Sharing Center, click Manage Network Connections. In Network Connections, right-click the connection you want to work with and then select Properties.
3. Double-click Internet Protocol Version 6 (TCP/IPv6) or internet protocol version 4 (TCP/IPv4) as appropriate for the type of IP address you are configuring.
4. For an IPv6 address, do the following:
 - Select Use The Following IPv6 Address and then type the IPv6 address in the IPv6 Address text box. The IPv6 address you assign to the computer must not be used anywhere else on the network.
 - Press the Tab key. The Subnet Prefix Length field ensures that the computer communicates over the network properly. Windows Server 2008 should insert a default value for the subnet prefix into the Subnet Prefix Length text box. If the network doesn't use variable-length subnetting, the default value should suffice. If your network does use variable-length subnets, you'll need to change this value as appropriate for your network.
5. For an IPv4 address, do the following:
 - Select Use The Following IP Address and then type the IPv4 address in the IP Address text box. The IPv4 address you assign to the computer must not be used anywhere else on the network.
 - Press the Tab key. The Subnet Mask field ensures that the computer communicates over the network properly.

C LAB MANUAL

6. If the computer needs to access other TCP/IP networks, the internet, or other subnets, you must specify a default gateway. Type the IP address of the network's default router in the Default Gateway text box.
7. DNS is needed for domain name resolution. Select Use The Following DNS Server Addresses and then type a preferred address and an alternate DNS server address in the text boxes provided.
8. When you're finished, click OK three times to save your changes. Repeat this process for other network adapters and IP protocols you want to configure.

Configuring dynamic IP addresses and alternate IP addressing

Many organizations use DHCP servers to dynamically assign IPv4 and IPv6 addresses. To receive an IPv4 or IPv6 address, client computers use a limited broadcast to advertise that they need to obtain an IP address. Dhcp servers on the network acknowledge the request by offering the client an IP address. The client acknowledges the first offer it receives, and the DHCP server in turn tells the client that it has succeeded in leasing the IP address for a specified amount of time. The message from the DHCP server can, and typically does, include the IP addresses of the default gateway, the preferred and alternate DNS servers, and the preferred and alternate WINS servers. This means these settings wouldn't need to be manually configured on the client computer.

Configuring multiple IP addresses and gateways

Using advanced TCP/IP settings, you can configure a single network interface on a computer to use multiple IP addresses and multiple gateways. This allows a computer to appear to be several computers and to access multiple logical subnets to route information or to provide internetworking services. The best way to configure multiple gateways depends on the configuration of your network. If your organization's computers use DHCP, you'll probably want to configure the additional gateways through settings on the DHCP server. If computers use static IP addresses or you want to set gateways specifically, assign them by following these steps:

C LAB MANUAL

1. Click Start and then click Network. In Network Explorer, click Network and Sharing Center on the toolbar.
2. In Network and Sharing Center, click Manage Network Connections. In Network Connections, right-click the connection you want to work with and then select Properties.
3. Double-click Internet Protocol Version 6 (TCP/IPv6) or internet protocol version 4 (TCP/IPv4) as appropriate for the type of IP address you are configuring.

Click Advanced to open the Advanced TCP/IP Settings dialog box. Figure shows advanced settings for IPv4. The dialog box for IPv6 is similar

Step 1: double click on local area connection:



Step 2: double click on TCP/IPv4

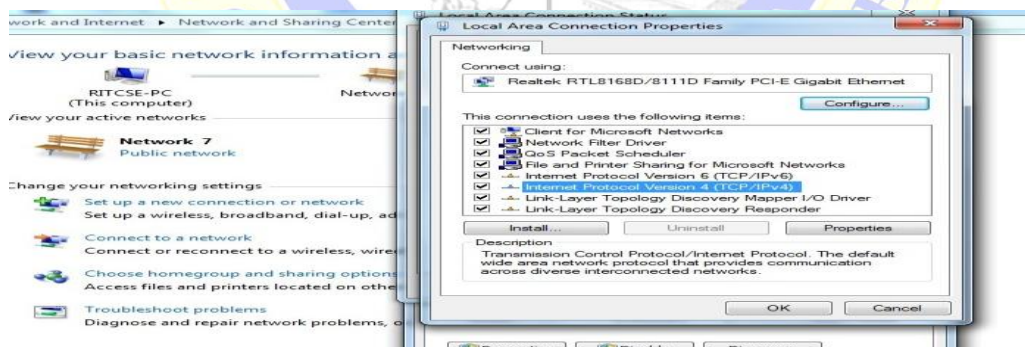

assign a IP address in TCP/IPv4

Step 3:

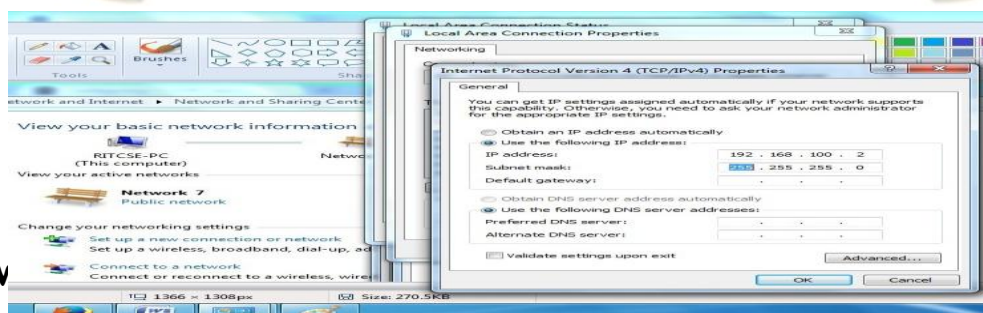

C LAB MANUAL

Step 4: click ok

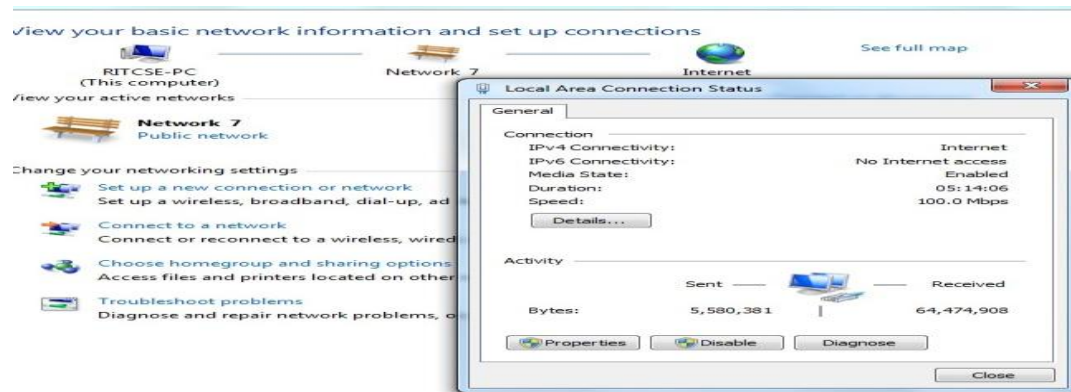

Step 5: any alternative IP addresses or subnet mask

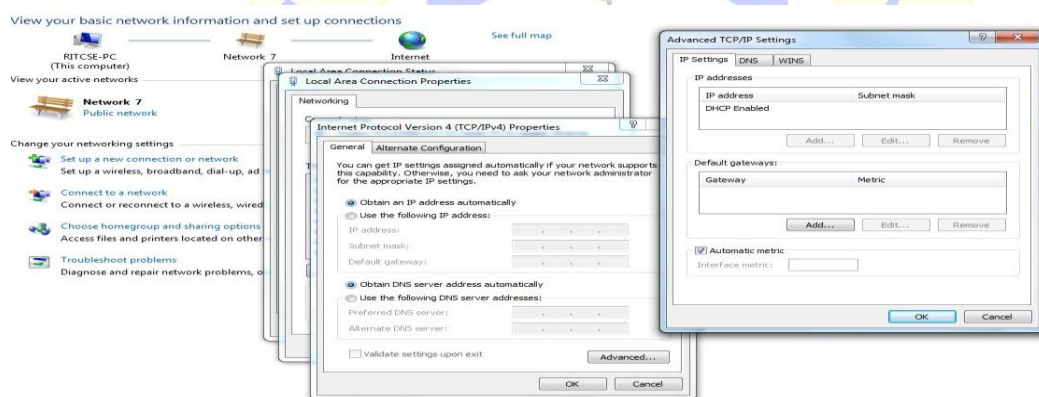

Proxy and firewall:

To configure the Web Proxy client browser to automatically detect its settings:

1. Start Internet Explorer 5.0 or later.
2. On the Tools menu, click Internet Options.
3. Click the Connections tab.
4. Click LAN Settings.
5. Click to select the automatically detect settings check box, click OK, and then click OK again.

C LAB MANUAL**Verify firewall or proxy server settings**

If the Master Database is downloaded through a firewall or proxy server that requires authentication, ensure that a browser on the Filtering Service machine can load Web pages properly. If pages open normally, but the Master Database does not download, check the proxy server settings in the Web browser.

Microsoft Internet Explorer:

1. Select Tools > Internet Options.
2. Open the Connections tab.
3. Click LAN Settings. Proxy server configuration information appears under Proxy server.

Make a note of the proxy settings.

Mozilla Firefox:

1. Select Tools > Options > Advanced.
2. Select the Network tab.

Click Settings. The Connection Settings dialog box shows whether the browser is configured to connect to a proxy server.

Make a note of the proxy settings.

Next, make sure that Websense software is configured to use the same proxy server to perform the download.

1. Go to Settings > General > Database Download.

Verify that Use proxy server or firewall is selected, and that the correct server and port are listed.

3. Make sure that the Authentication settings are correct. Verify the user name and password,

C LAB MANUAL

checking spelling and capitalization.

If Websense software must provide authentication information, the firewall or proxy server must be configured to accept clear text or basic authentication. Information about enabling basic authentication is available from the Websense Knowledge Base.

If a firewall restricts Internet access at the time Websense software normally downloads the database, or restricts the size of a file that can be transferred via HTTP, Websense software cannot download the database. To determine if the firewall is causing the download failure, search for a rule on the firewall that might be blocking the download, and change the download times in TRITON - Web Security (Configuring database downloads), if necessary.

How To Install Application Software on the Computer

A software generally refers to any type of executable code that can be launched in a computer system. It is designed to implement and complete specific functions that are required by the user in his activities. Software can be developed and distributed freely (freeware) by programmers in various communities and forums, or they can be sold commercially either online or in computer stores by software companies like Microsoft, Adobe, and Sony among others. Some computer experts believe that software can be categorized as general application (can be installed and used by any organization) or customized (developed to cater to the specific needs of a particular group or enterprise). General application software like the Microsoft Office Productivity Suite for example can also be customized and tailor fitted to the needs of a specific organization. This is done by using macro commands and a bit of programming.

Materials Needed:

- Computer
- CD or DVD drive
- Installation disc
- Internet connection
- Web browser

C LAB MANUAL**Step 1**

The first most important step in software installation is to verify that the target system meets the general hardware requirements of the application. Beginning the installation in a computer machine which does not possess the minimum requirements can lead to either an unsuccessful installation or failure of the program to run after installing it.

Step 2

Since programs in general are written to be Operating System dependent, make sure that the version of the application you are installing corresponds to the Operating System platform running on your machine.

Step 3

Aside from the general hardware requirements, some computer programs also have software requirements prior to installation. Double check if you need to update or upgrade your Operating System or if there is a need to download other tools or utilities.

Step 4

Once all the initial requirements have been met, make sure that there are no unnecessary programs running before beginning the installation procedure. In some instances, applications may require that the antivirus programs be disabled. Make sure that you are installing a legitimate application before disabling your protection software.

Step 5

Software installation can be done either from the Internet (skip to step 8) or from an installation disc provided by the software manufacturer. To install from the disc, simply open the CD or DVD drive and insert the installer.

Step 6

A setup wizard window should be launched. In case there is none, open the Explorer and navigate to the optical drive. Double click on either the Autorun or Setup file.

C LAB MANUAL**Step 7**

Once the wizard is running, simply follow the prompts until the installation process is completed. For novice users, accept the default values to minimize potential problems during the procedure. Jump to step 10.

Step 8

For installation from the Web, launch your browser application and download the setup file to your hard drive.

Step 9

After completion of the downloading process, run the setup program to execute the setup wizard that will handle the automatic installation of the software. Do step 7.

Step 10

After the installation procedure has been completed and the setup wizard has terminated, reboot your machine before launching the newly installed software.

System software

System software (systems software) is computer software designed to provide services to other software. Examples of system software include operating systems, computational science software, game engines, industrial automation, and software as a service applications. In contrast to system software, software that allows users to do things like create text documents, play games, listen to music, or web browsers to surf the web are called application software. The line where the distinction should be drawn is not always clear. Many operating systems bundle application software. Such software is not considered system software when it can be uninstalled usually without affecting the functioning of other software. A programming tool or software development tool is a computer program that software developers use to create, debug, maintain, or otherwise support other programs and applications. The term usually refers to relatively simple programs, that can be combined together to accomplish a task, much as one might use multiple hand tools to fix a physical object. The ability to use a variety of tools productively is

C LAB MANUAL

one hallmark of a skilled software engineer. The most basic tools are a source code editor and a compiler or interpreter, which are used ubiquitously and continuously. Other tools are used more or less depending on the language, development methodology, and individual engineer, and are often used for a discrete task, like a debugger or profiler. Tools may be discrete programs, executed separately – often from the command line – or may be parts of a single large program, called an integrated development environment (IDE). In many cases, particularly for simpler use, simple ad hoc techniques are used instead of a tool, such as print debugging instead of using a debugger, manual timing (of overall program or section of code) instead of a profiler, or tracking bugs in a text file or spreadsheet instead of a bug tracking system.

VIVA-VOCE QUESTIONS:

1. What is the usage of spread sheet?
2. What is the need of PowerPoint?
3. What is IP address?
4. What is the use of MS office?
5. What is the extension of word document?

C LAB MANUAL**ADVANCED EXPERIMENT-1**

AIM: Write C programs that implement stack (its operations) using arrays

DESCRIPTION: Stack is a linear data structure where it restricts operations to only one end. That end is called as “**TOP**”. Stack works on the principle of “**last in first out**” (**LIFO**). Operations to insert an element are stack is called “**PUSH**”. And deleting an element from stack is called “**POP**”.

ALGORITHM:

/*Implementation of push operation on a stack

*/

procedure PUSH(STACK, n, top, item)

if (top = n) then

STACK_FULL; else

{

top = top + 1;

STACK[top] = item; /* store item as top element of STACK */

}

end PUSH

/*Implementation of pop operation on a stack; */

procedure POP(STACK, top, item)

if (top = 0) then

STACK_EMPTY; else

{

item = STACK[top];

top = top - 1;

}

end POP

C LAB MANUAL**Procedure**

```

Display() if top =
-1 then
    print _ Stack is empty'
else
{
    i=0;
    while(top>0)
    do
        print _stack[i];
        i++;
    end while.
}
end Display.

```

SAMPLE OUTPUT:

Menu

1.push

2.pop

Enter your choice 1

Enter the element to insert 50

Do you wish to continue press y for yes and n for no: y

Menu

1.push

2.pop

Enter your choice 1

Enter the element to insert 20

Do you wish to continue press y for yes and for no:n

Stack elements are: 20 50

C LAB MANUAL**ADVANCED EXPERIMENT-2**

AIM: Write C programs that implement stack (its operations) using linked list.

DESCRIPTION: The major problem with the stack using array is, it works only for fixed amount of numbers of data values. That means the amount of data must be specified at the beginning of the implementation itself. Stack implemented using array is not suitable, when we don't know the size of the data which we are going to use. A stack data structure can be implemented by using linked list data structure. The stack implemented using linked list can work for unlimited number of values. That means the stack implemented using linked list can work for variable size of data. So there is no need to fix the size at the beginning of implementation.

ALGORITHM:

Algorithm: Push item ITEM into a linked stack S with top pointer TOP

procedure PUSH_LINKSTACK (TOP, ITEM)

/* Insert ITEM into

stack */ Call

GETNODE(X)

DATA(X) = ITEM /*frame node for ITEM */

LINK(X) = TOP /* insert node X into stack */

TOP = X /* reset TOP pointer */

end PUSH_LINKSTACK.

Algorithm: Pop from a linked stack S and output the element through ITEM

procedure POP_LINKSTACK(TOP, ITEM)

/* pop element from stack and set ITEM to the element

*/ if (TOP = 0) then call LINKSTACK_EMPTY

/* check if linked stack is

empty */ else {

TEMP = TOP

C LAB MANUAL

```

    ITEM =
    DATA(TOP) TOP =
    LINK(TOP)
    }
call RETURN(TEMP)
; end
POP_LINKSTACK.

```

Algorithm for display**Procedure Display()**

```

Ptr<-top
if ptr=NULL then
    display Stack is empty
else
{ While(ptr!=NULL)
  do
    display ptr->item
    ptr=ptr->next
  end while.
}
end Display.

```

SAMPLE OUTPUT:

Linked stack

- 1.Push
- 2.Pop
- 3.Display

Enter your choice 1

Enter the number 18

Linked stack

C LAB MANUAL

1. Push
2. Pop
3. Display

Enter your choice 3

Stack elements: 18

VIVA-VOCE QUESTIONS:

1. What is stack?
2. What are various implementations of stack?
3. What are the basic operations on stack?
4. How to allocate memory dynamically?

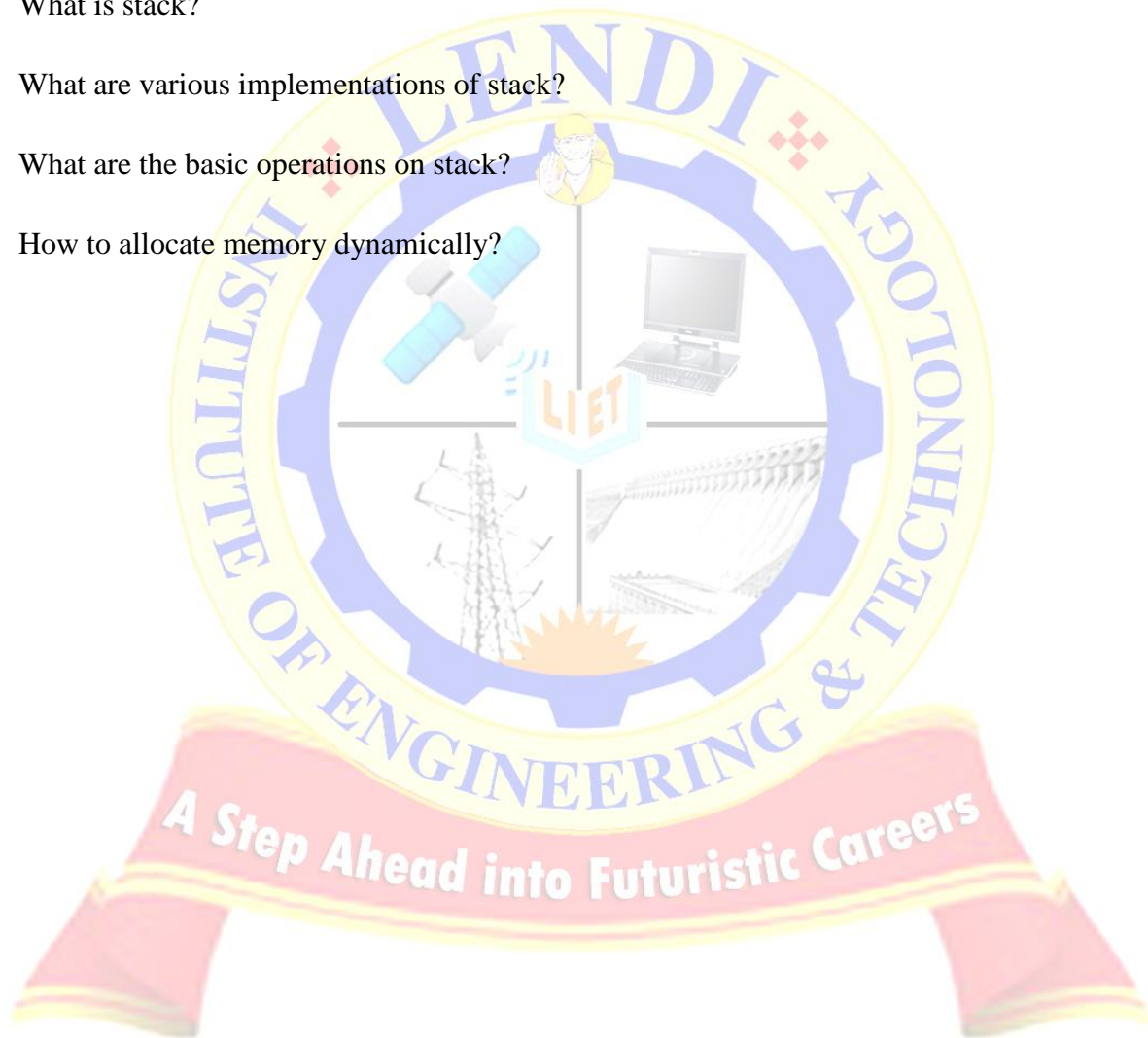

C LAB MANUAL**DESIGN EXPERIMENT-1**

AIM: Write a C program to find the largest of three numbers using ternary operator.

DESCRIPTION: First get the greatest among two then get the greatest among that and remaining number. We can use ternary operator to do this.

Syntax of ternary operator(?:):

Exp1? Exp2 : Exp3;

ALGORITHM:

INPUT: Three Numbers

OUTPUT: Greatest among the three

STEP-1: Start

STEP-2: Read a,b,c

STEP-3: If a>b then

 If a>c then

 d=a

 Otherwise

 d=c

Otherwise

 If b>c then

 d=b

 Otherwise

 d=c

STEP-4: Display d

STEP-5: Stop

C LAB MANUAL**SAMPLE OUTPUT:**

Enter 3 numbers:

1 2 3

Greatest number is: 3

VIVA-VOCE QUESTIONS:

6. What is ternary operator?
7. What is the syntax of ternary operator?
8. How ternary operator works?
9. Other name for ternary operator?

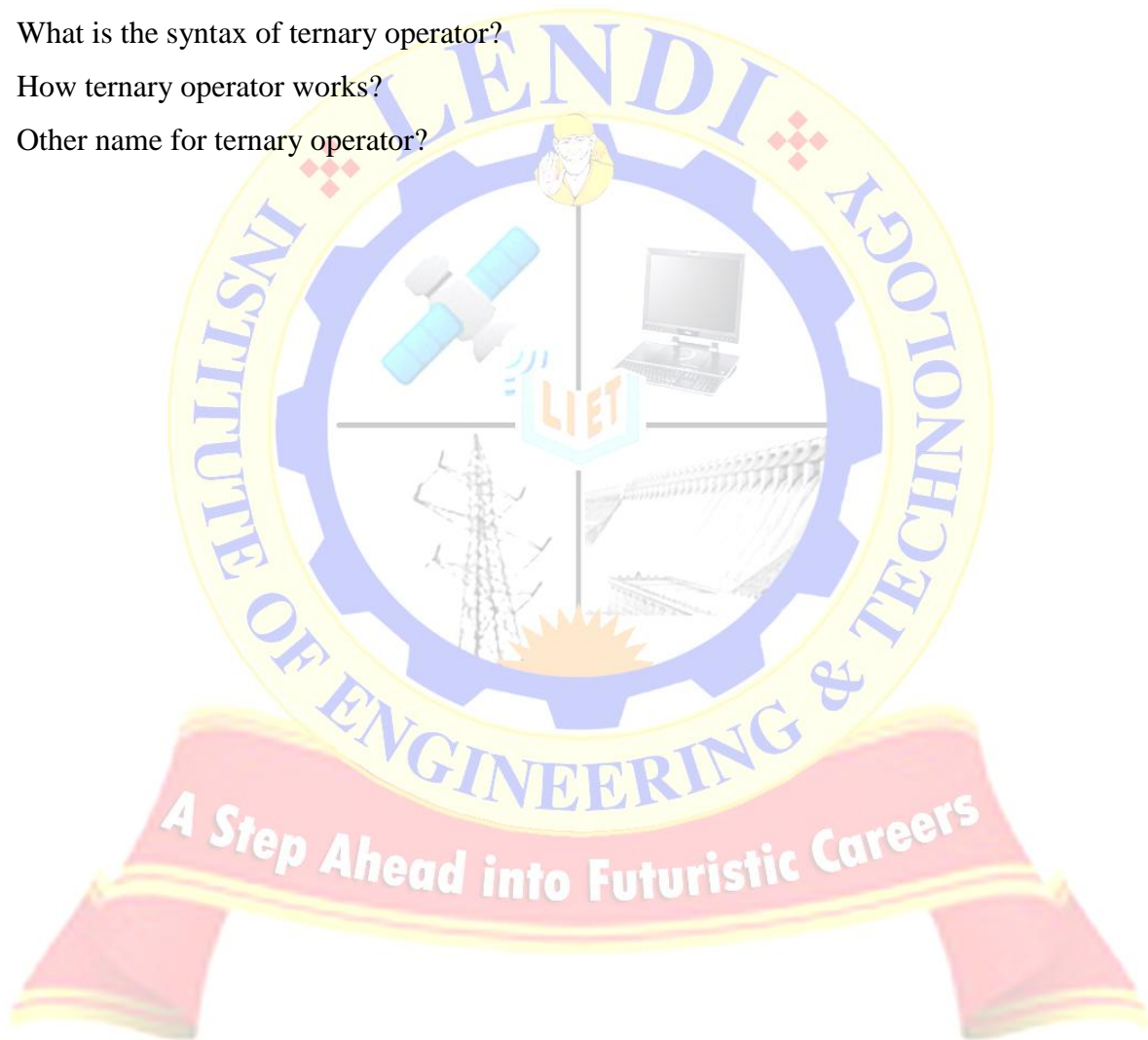

C LAB MANUAL**DESIGN EXPERIMENT-2**

AIM: Write a c program to interchange largest and smallest number in array.

DESCRIPTION: Find the position of smallest element in the array and find the position of largest element in the array. Now swap the elements at those positions.

ALGORITHM:

INPUT: An array (Collection of elements)

OUTPUT: Array with swapped smallest and largest elements.

STEP-1:Start

STEP-2:Read array a of size specified as n

STEP-3:Display the array before interchanging smallest and largest

STEP-4: Initialize i=0

STEP-5: Initialize s=a[0],l=a[0],si=0,li=0

STEP-6: Loop(i<n)

 If (l<a[i])

 {

 l=a[i]

 li=i

 }

 If (s>a[i])

 {

 s=a[i]

 si=i

 }

 i++

repeat loop

C LAB MANUAL

STEP-7:Swap the elements at the positions l_i and s_i in the array

STEP-8:Display the array after interchanging smallest and largest

STEP-9:Stop

SAMPLE OUTPUT:

Enter array elements

2 5 8 4 4 1

Before interchanging

2 5 8 4 4 1

After interchanging

2 5 1 4 4 8

VIVA-VOCE QUESTIONS:

1. How elements of array can be accessed?
2. What is swapping?
3. What is the range of index of an array?
4. What is size of an array?

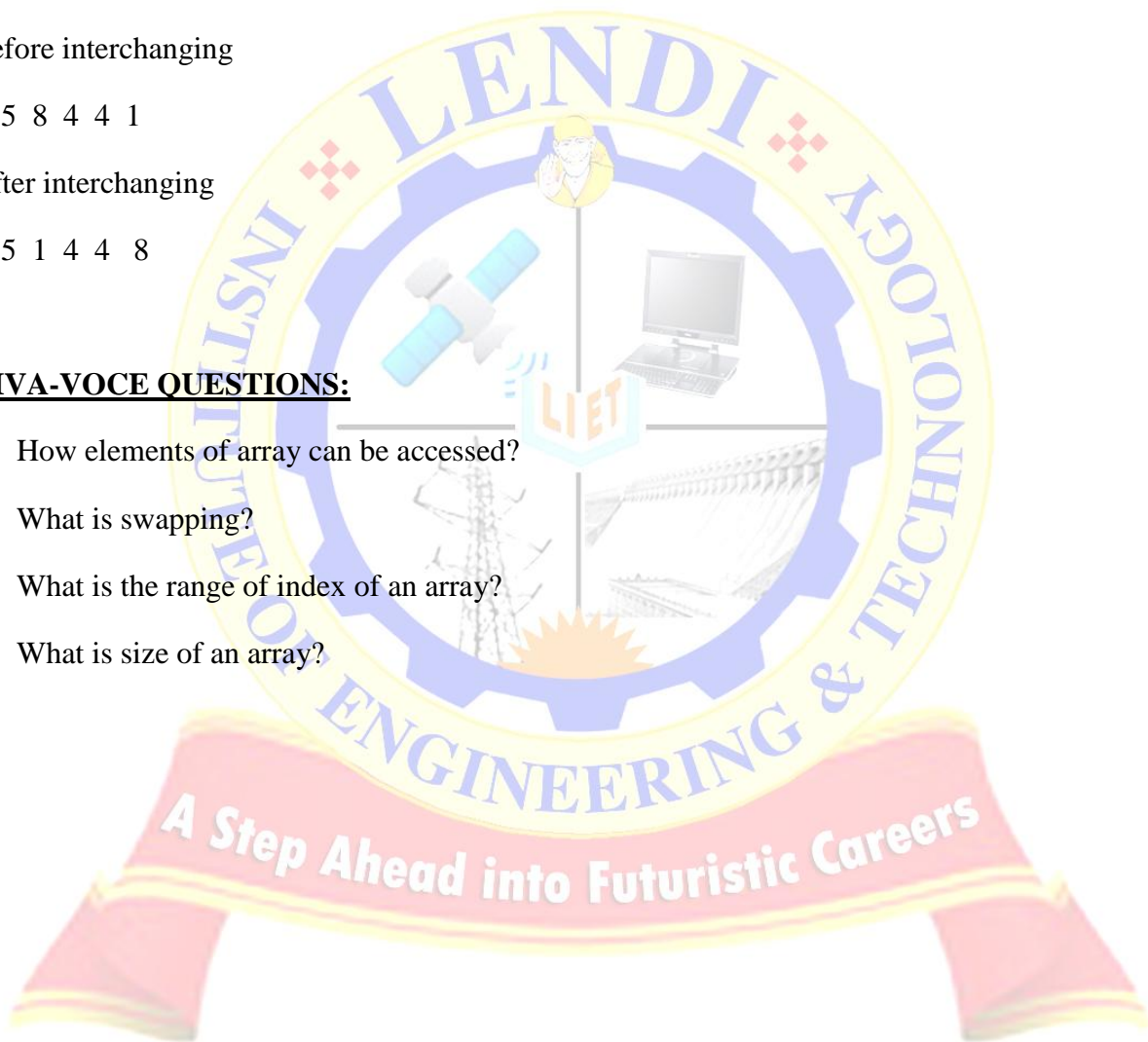

C LAB MANUAL**TOPICS BEYOND EXPERIMENT-1**

AIM: Program to illustrate macros.

DESCRIPTION: A macro is a pre-processor directive. We can use this to define constants.

Syntax : #define Macro value

Example: #define PI 3.14

ALGORITHM:

INPUT: radius of the circle.

OUTPUT: Area of circle.

Define the macro at the global declaration section of the program as given below

```
#define PI 3.14
```

STEP-1:Start

STEP-2: Read radius r

STEP-3: Compute area= $PI*r*r$

STEP-4: Display area

STEP-5: Stop

SAMPLE OUTPUT:

Enter radius:

2.5

Area of circle:

19.63

VIVA-VOCE QUESTIONS:

1. What is macro?
2. What is macro processor?

C LAB MANUAL

3. What happens after preprocessing?



C LAB MANUAL**TOPICS BEYOND EXPERIMENT-2**

AIM: Program to illustrate inter- program communication.

DESCRIPTION: Inter process communication is the process of communication between the processes while they are under execution. A simple such concept is done using extern-storage classes concept of C language. If different programs want to share same variable make it as a global variable in one program and refer it as extern variable from the other program.

There are 2 programs named as main.c and support.c such that the global variable of main.c is referred as extern-variable of support.c.

ALGORITHM:**First File: main.c**

Make the declaration of global variable count. And refer global function of support as extern function.

STEP-1: Start

STEP-2: Assign count=5

STEP-3: Call write_extern()

STEP-4: Stop

Second File: support.c

Refer global variable count of main.c as extern variable.

STEP-1: Start

STEP-2: Display count

STEP-3: Stop

SAMPLE OUTPUT: Make the compilation as `$gcc main.c support.c`

count is 5

C LAB MANUAL**VIVA-VOCE QUESTIONS:**

1. What is global variable?
2. What is extern variable?
3. What is inter process communication?

